



USOS GLOBALES

- RESIDENCIAL
- TERCIARIO
- INDUSTRIAL
- TURÍSTICO

Z-00 Zona Homogénea
0,00 Edificabilidad (m²/m²)
000 Densidad (viviendas/Ha)
 * N.F.= No se fija

LEY DE COSTAS

- Línea de Servidumbre de Protección
- Línea de Servidumbre de Tránsito
- Línea de Deslinde
- Línea de Ribera de Mar



SITUACION EN EL P.G.O.U.

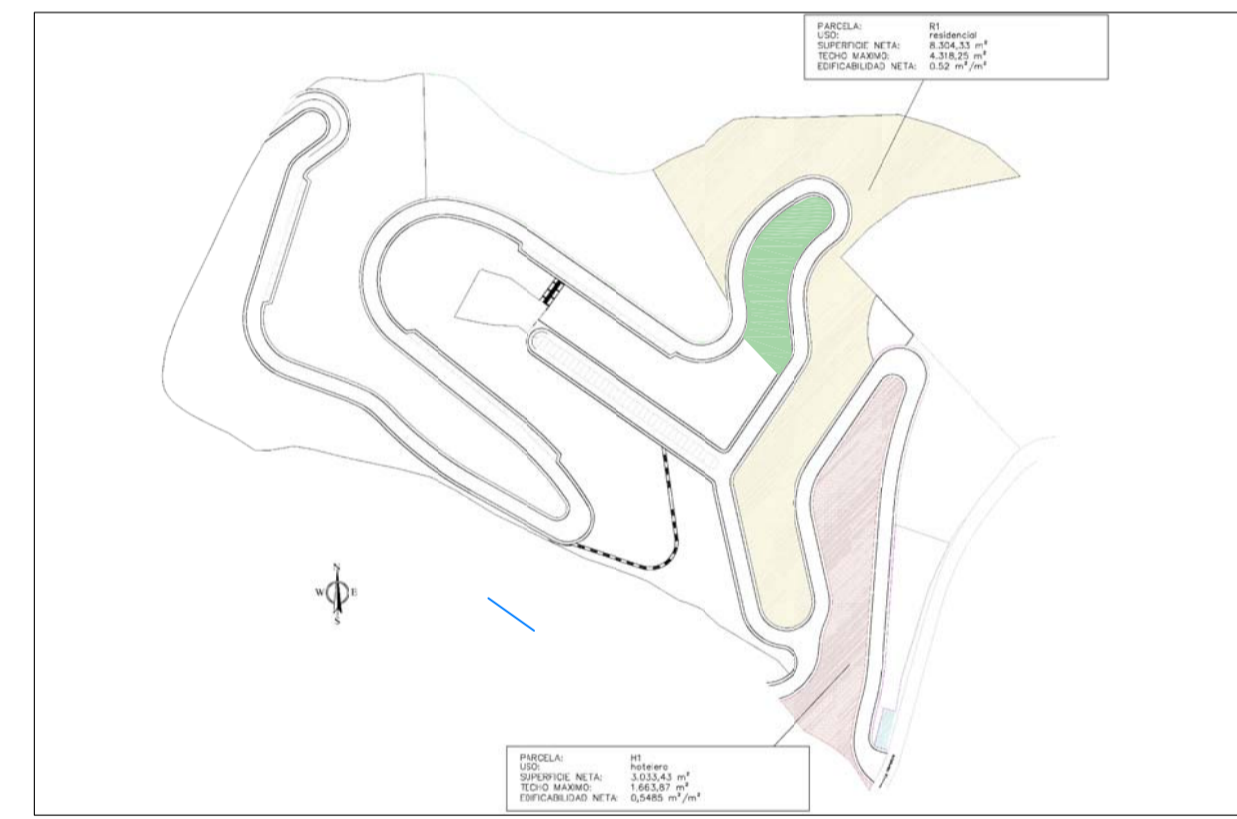

SITUACION EN P.P LAS MARAVILLAS

CONSULTA DESCRIPTIVA Y GRÁFICA DE DATOS CATASTRALES DE BIEN INMUEBLE
 Referencia catastral: 4355158VFS4SE00002E

DATOS DESCRIPTIVOS DEL INMUEBLE

Localización: PL. P.P. SECTOR LAS MARAVILLAS Sudo
 16500 ALBUFENICAR (MURCIA)

Clase: URBANO

Uso principal: Ocio/Recreación
 Superficie construida: 173 m²
 Año construcción: 1998

Construcción

Destino	Existencia / Planta / Fuente	Superficie m ²
Residencial	100	173

PARCELA

Superficie gráfica: 10.337 m²
 Participación del inmueble: 100,00 %
 Tipo: Parcela construida en división horizontal

Este documento no es una certificación catastral, pero sus datos pueden ser verificados a través del "Acceso a datos catastrales no protegidos de la SEC".

Murcia, 29 de Septiembre de 2020

FICHA CATASTRAL



FOTOGRAFÍA AÉREA

CUMBRE VILLAS
 Amazing Villas, Stunning Views

+34 958 611 809
 +34 647 881 853
 sales@cumbrevillas.com
 www.cumbrevillas.com

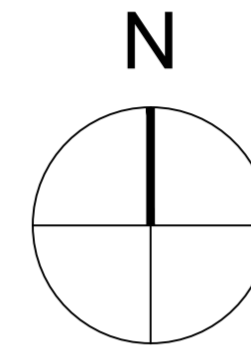
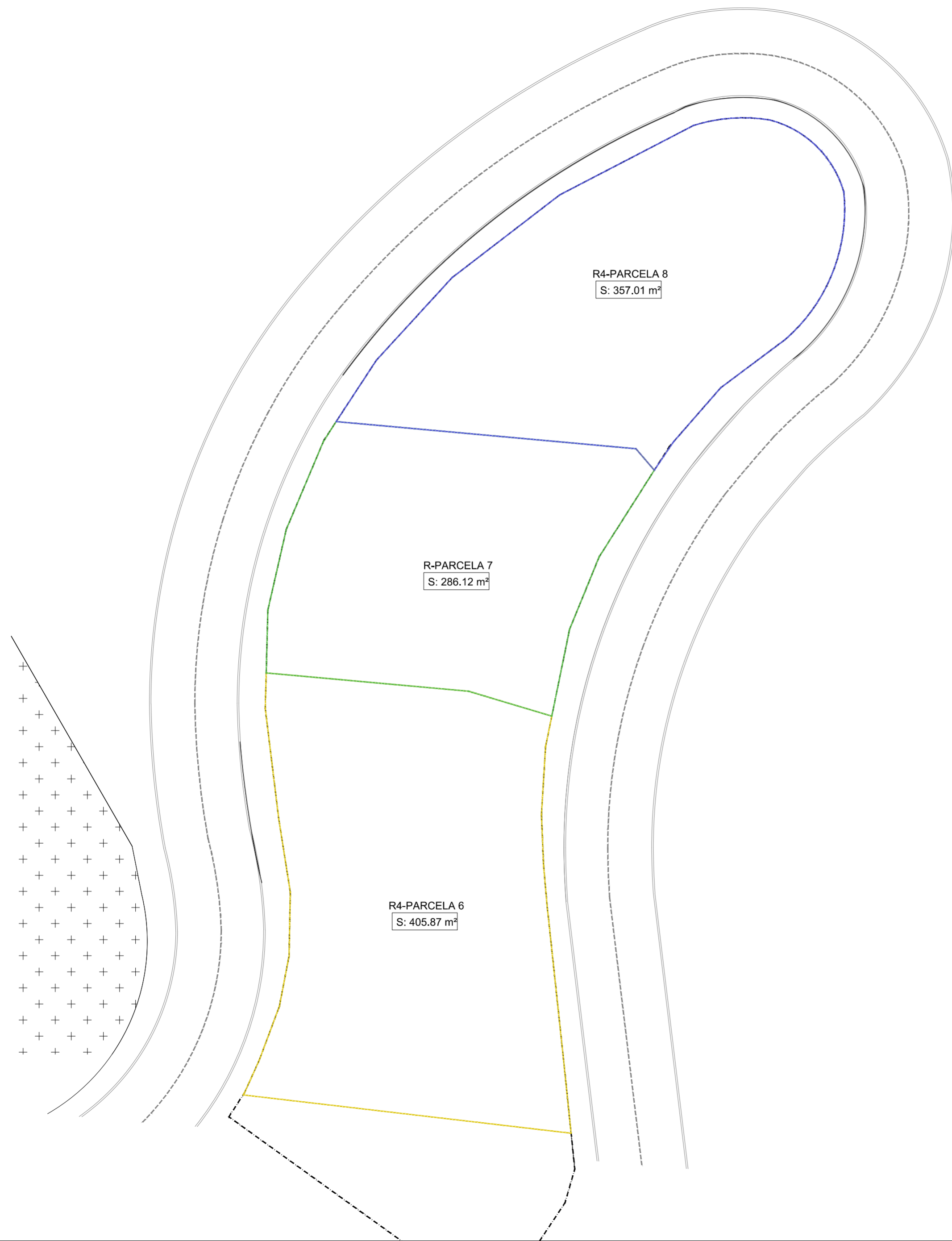

CUMBRE VILLAS
Amazing Villas, Stunning Views

+34 958 611 809

+34 647 881 853

sales@cumbrevillas.com

www.cumbrevillas.com

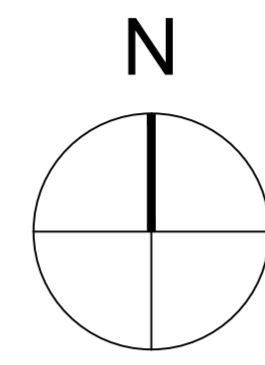
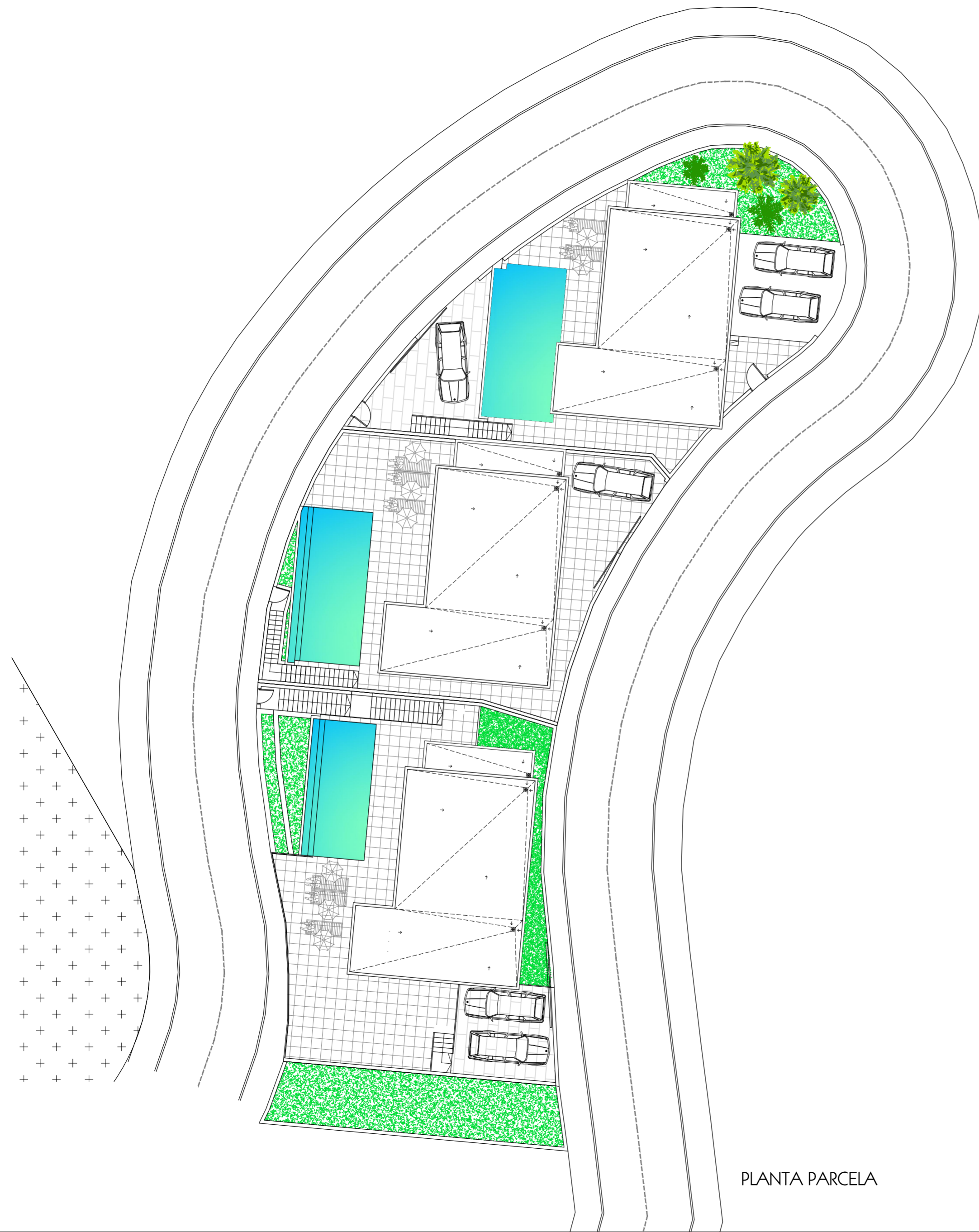

PLANTA PARCELA



CUMBRE VILLAS
Amazing Villas, Stunning Views

+34 958 611 809

+34 647 881 853

sales@cumbrevillas.com

www.cumbrevillas.com



ALZADO OESTE

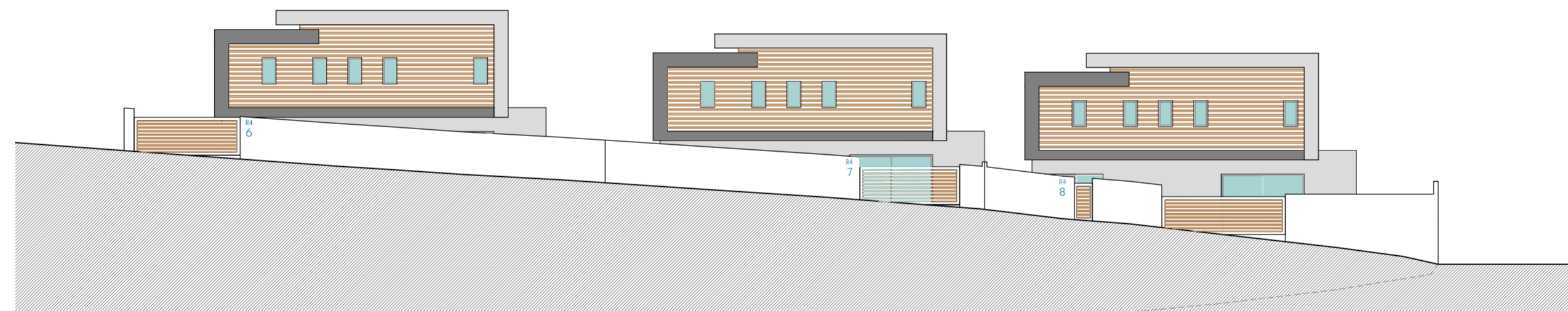

ALZADO ESTE



SECCION AA'

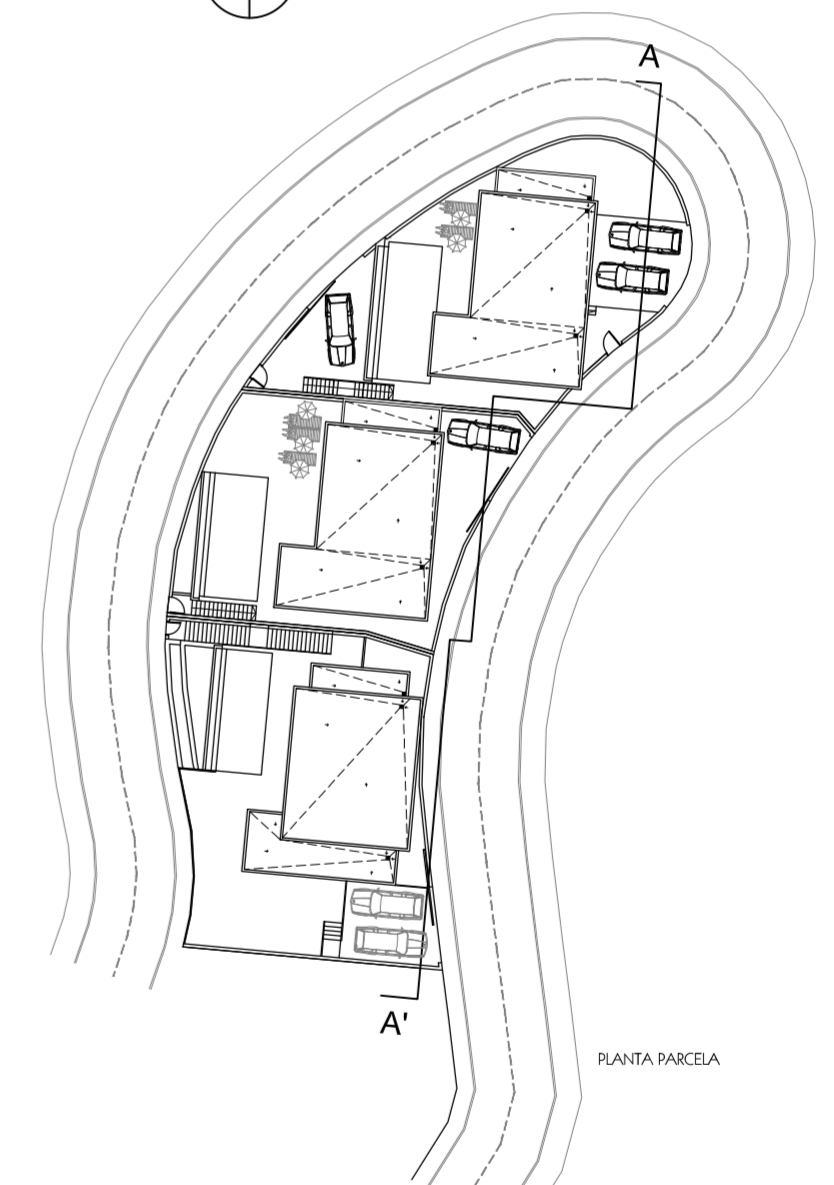

CUMBRE VILLAS

Amazing Villas, Stunning Views

+34 958 611 809

+34 647 881 853

sales@cumbrevillas.com

www.cumbrevillas.com

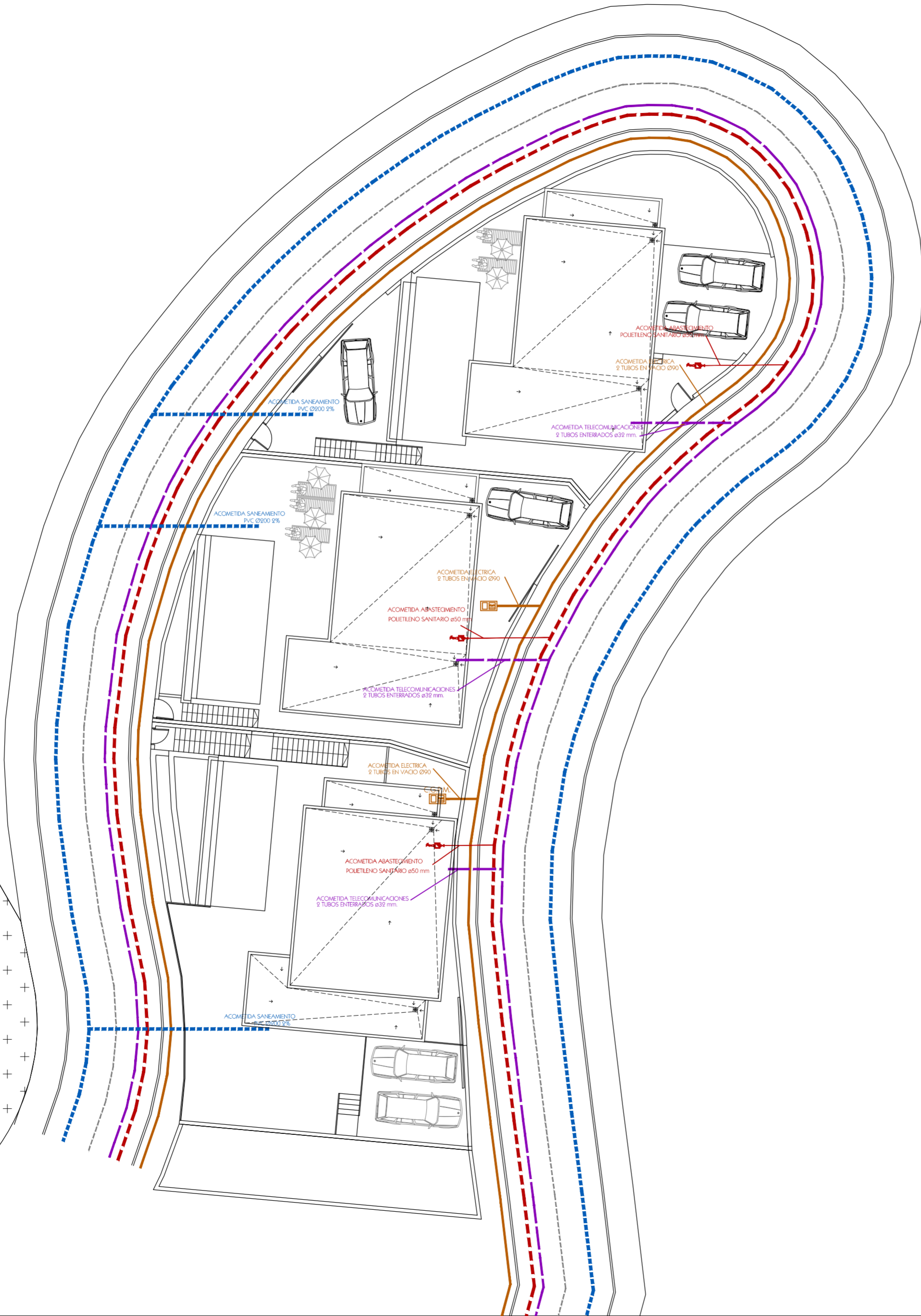
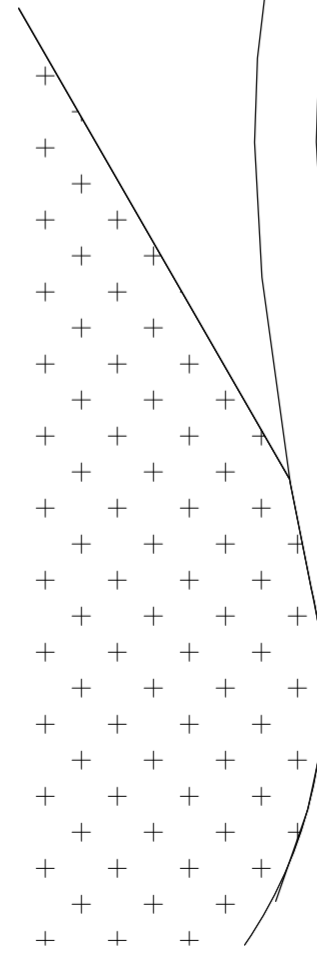
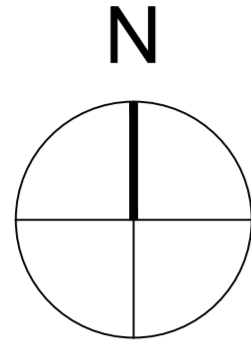

INSTALACIONES Y URBANIZACION

- Red de saneamiento de aguas fecales.
- Red de abastecimiento de agua potable.
- Red General Electrica - Solicitar condiciones de conexon de obra y definitiva a la Cia suministradora (Sevillana-Endesa)
- Red de telefonía - solicitar condiciones de conexon a la Cia suministradora - Telefonica

Nota: Se consultaran y adaptaran todas las acometidas a la normativa de las compañías suministradoras



CUMBRE VILLAS
Amazing Villas, Stunning Views

+34 958 611 809

+34 647 881 853

sales@cumbrevillas.com

www.cumbrevillas.com

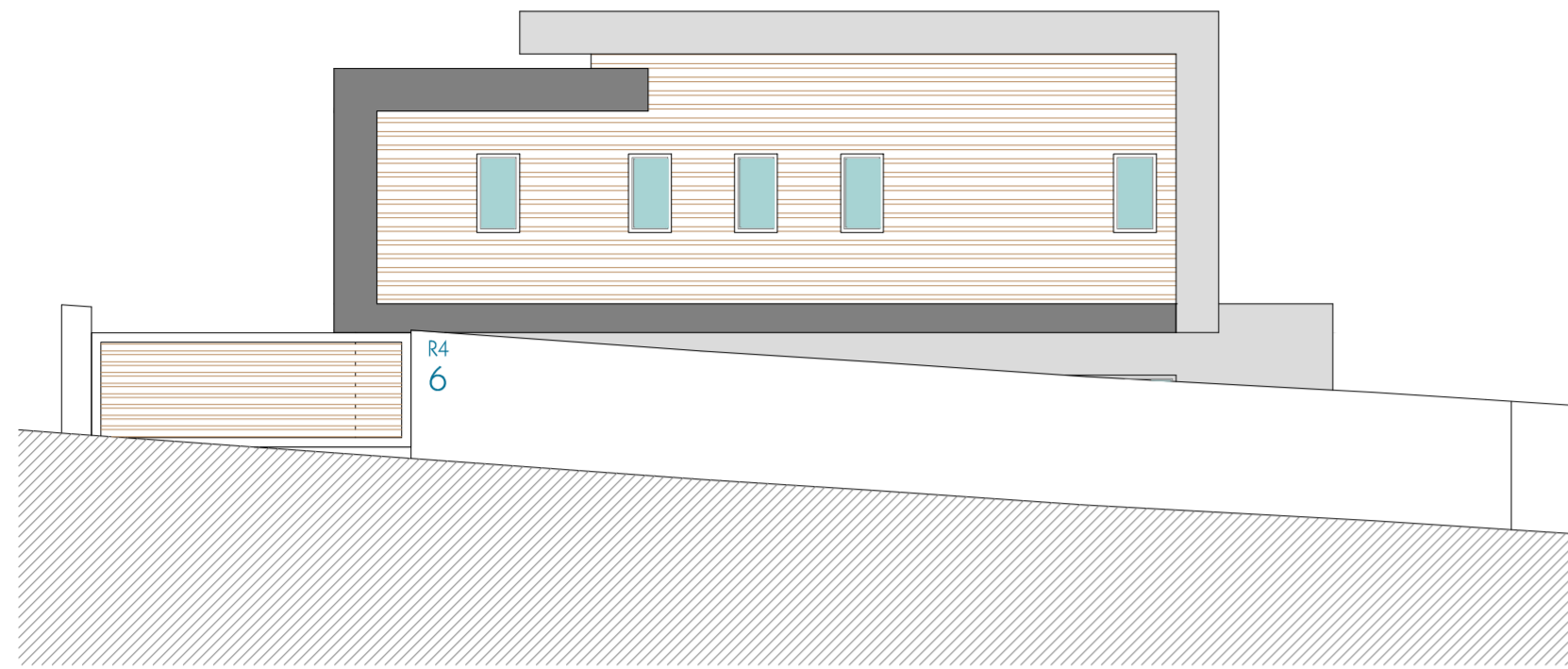

ALZADO ESTE

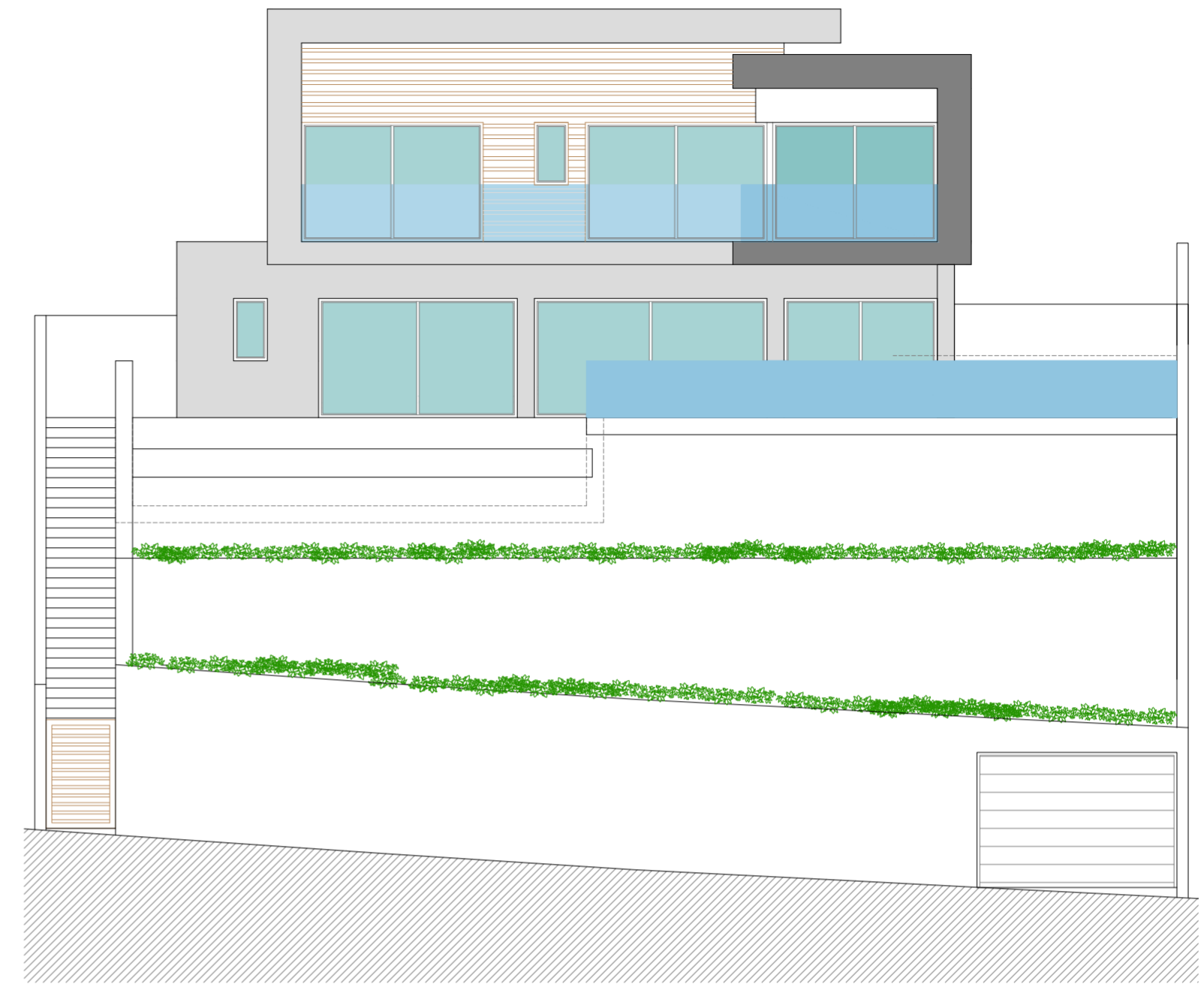

ALZADO OESTE

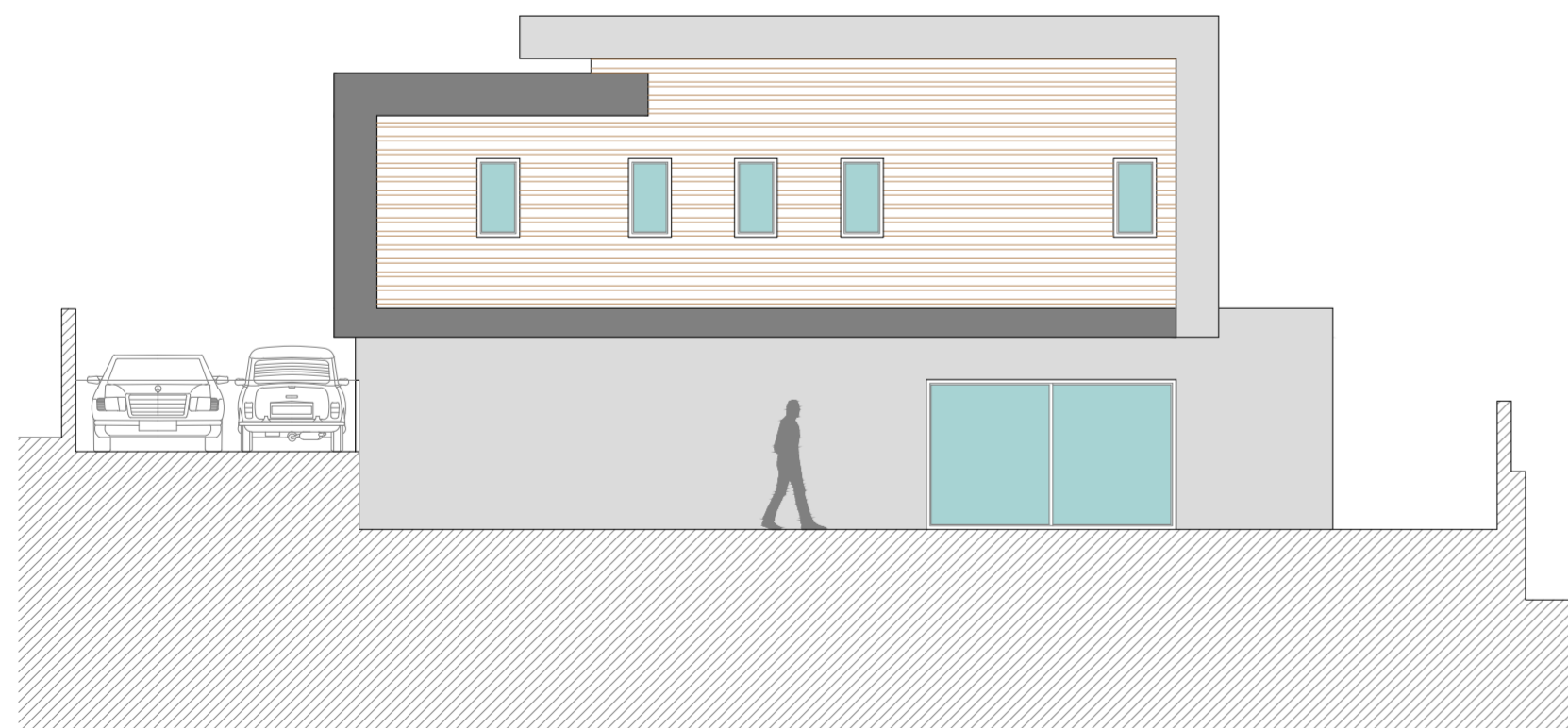

SECCION AA'

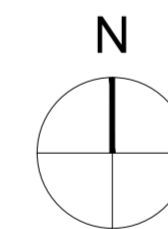
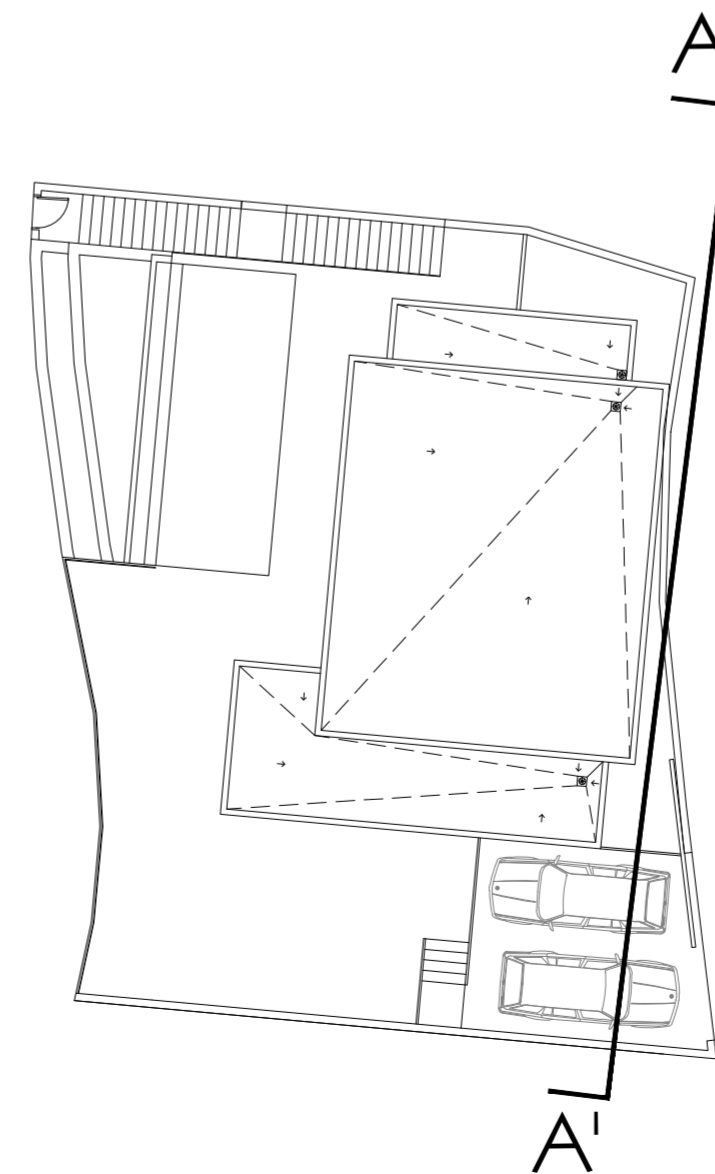

CUMBRE VILLAS
Amazing Villas, Stunning Views

+34 958 611 809

+34 647 881 853

sales@cumbrevillas.com

www.cumbrevillas.com

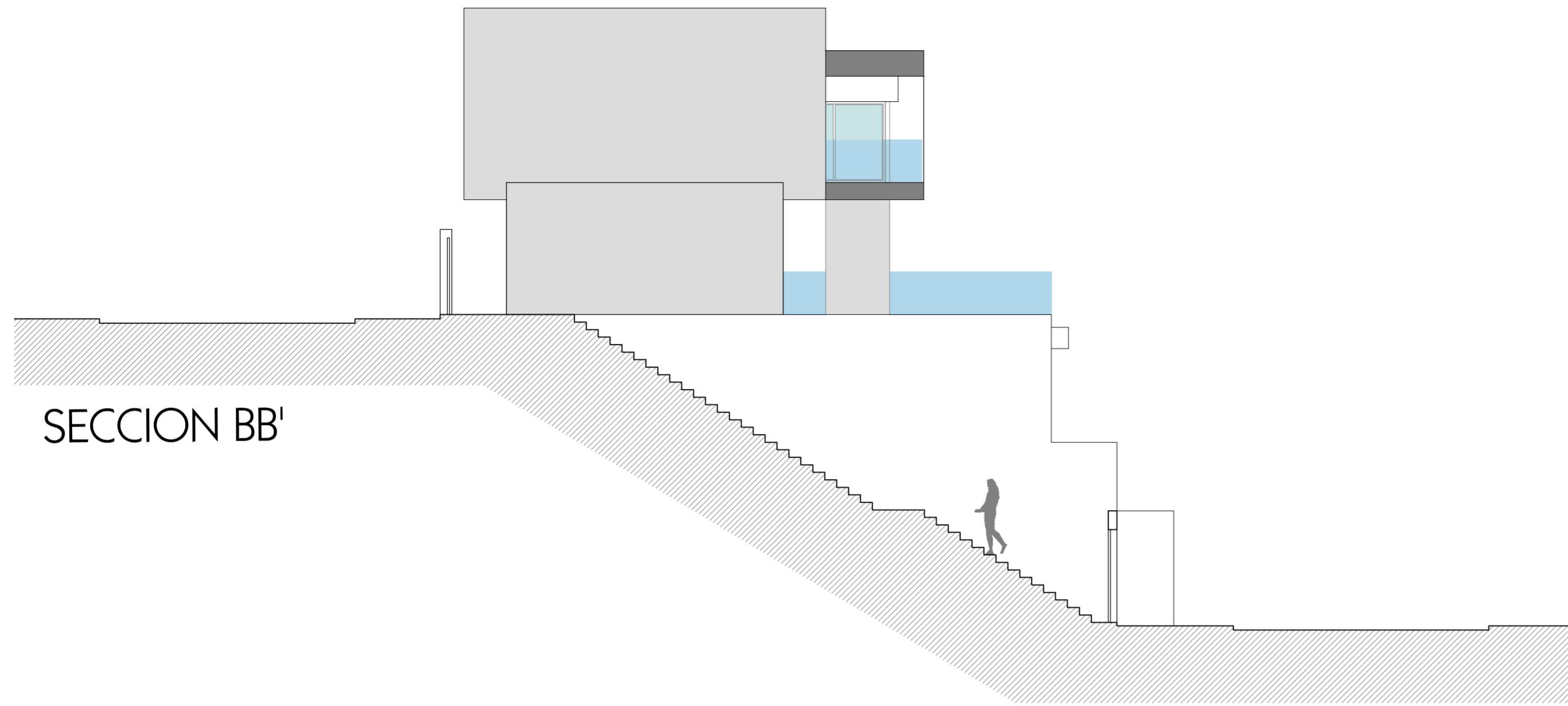

SECCION BB'

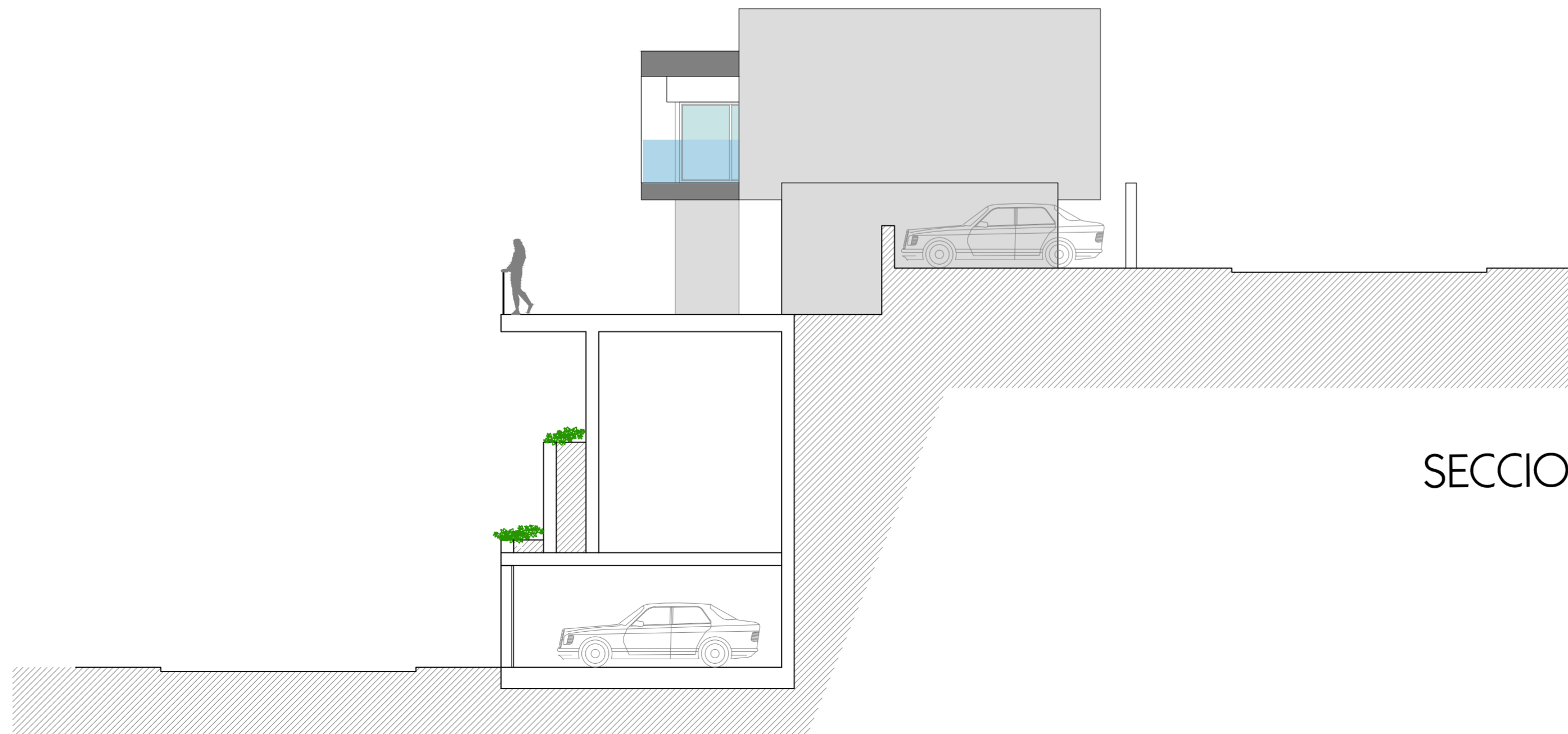

SECCION CC'

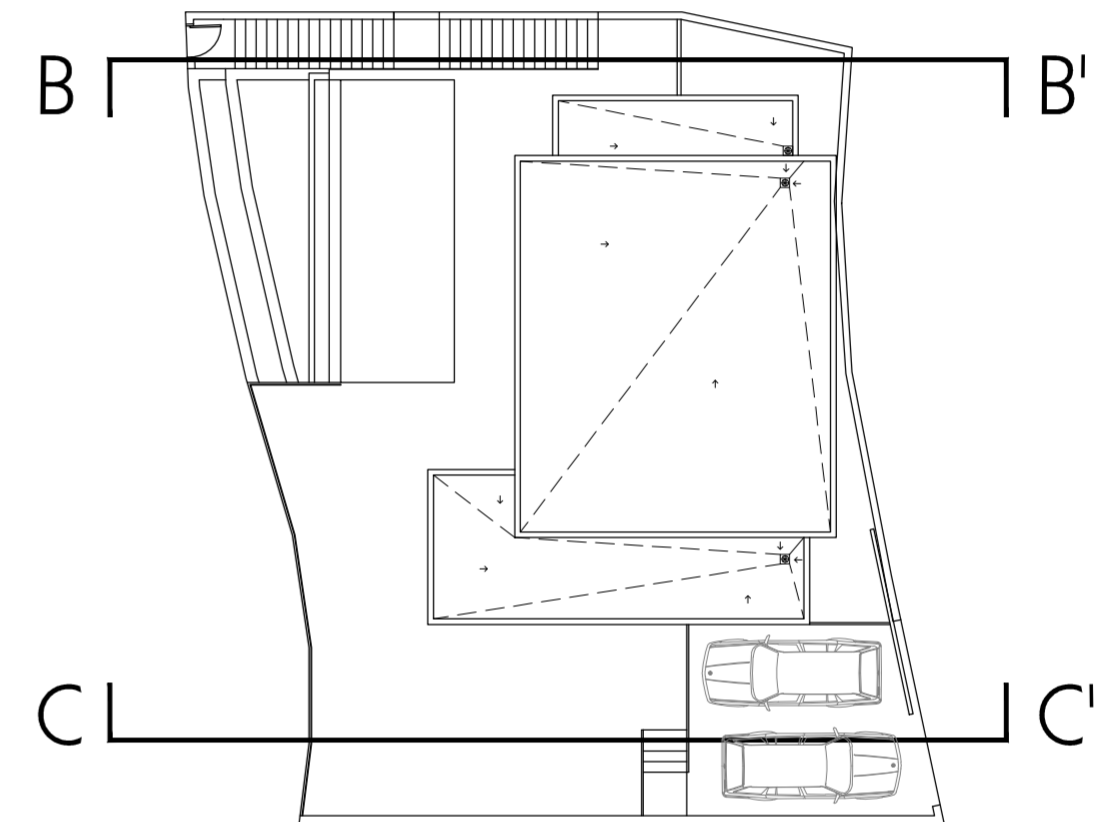

CUMBRE VILLAS
Amazing Villas, Stunning Views

+34 958 611 809

+34 647 881 853

sales@cumbrevillas.com

www.cumbrevillas.com

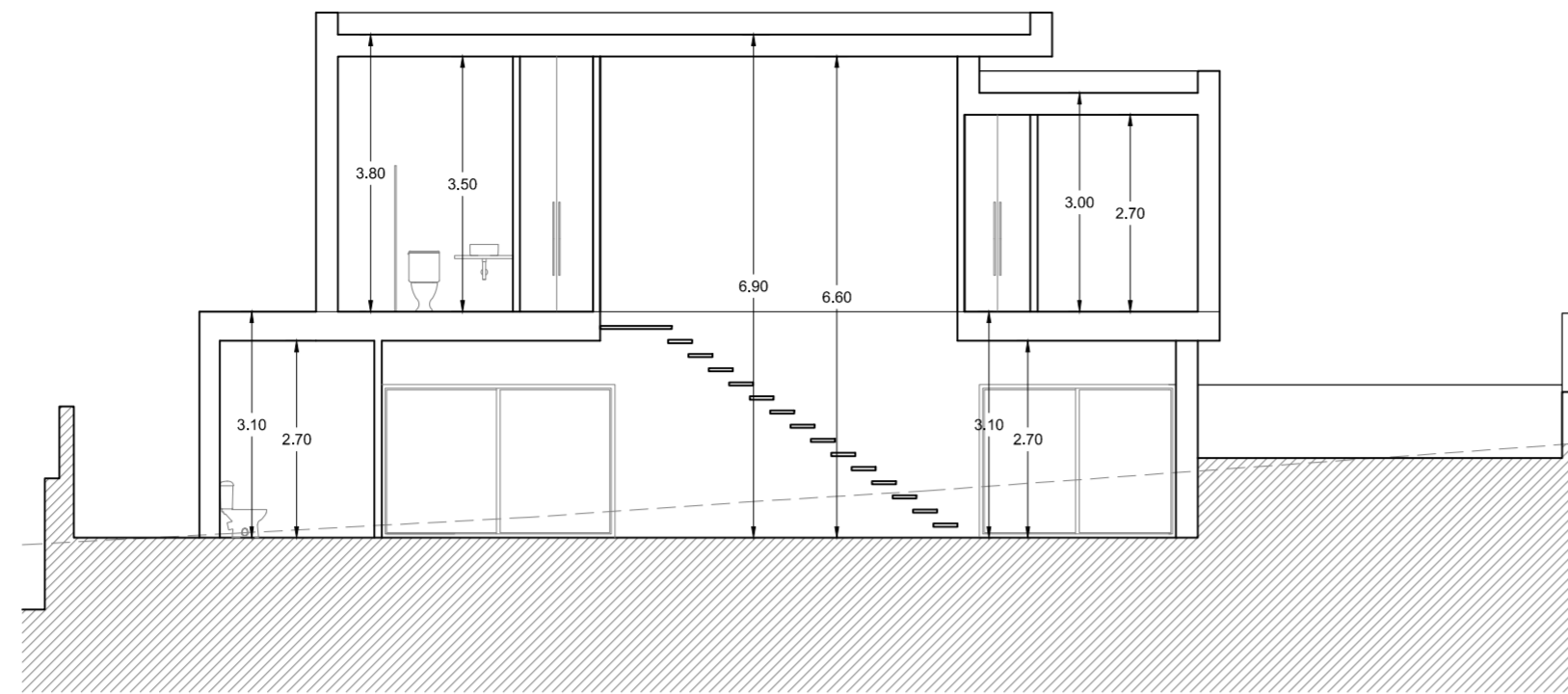

SECCION FF'

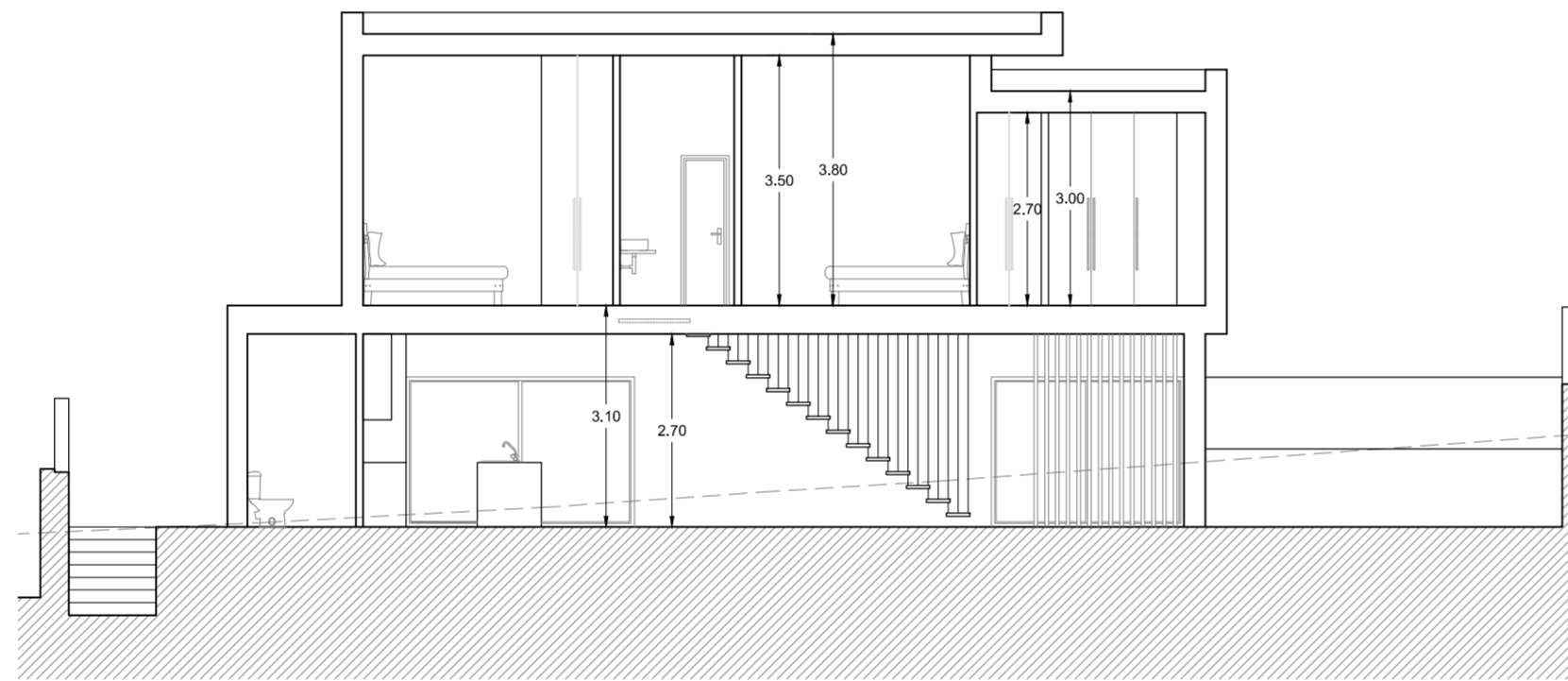

SECCION EE'

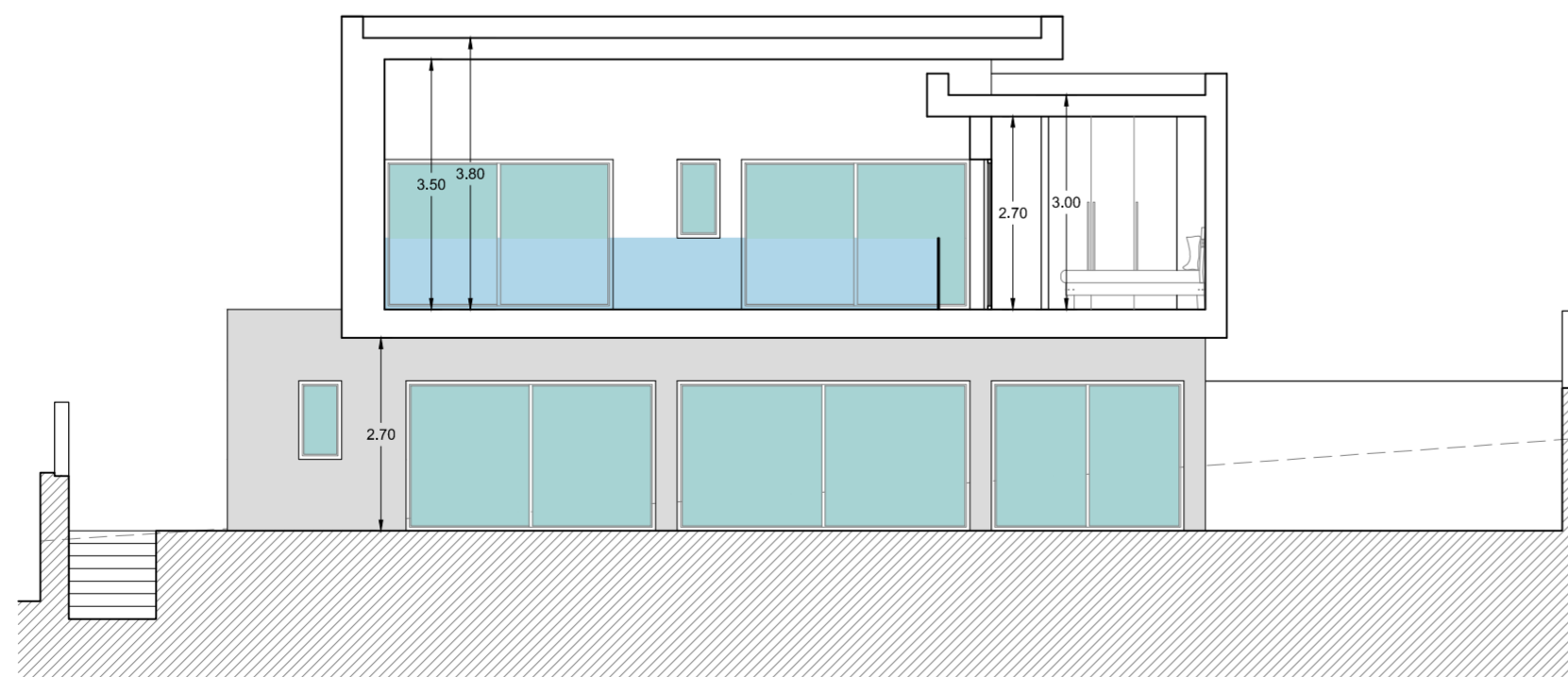

SECCION DD'

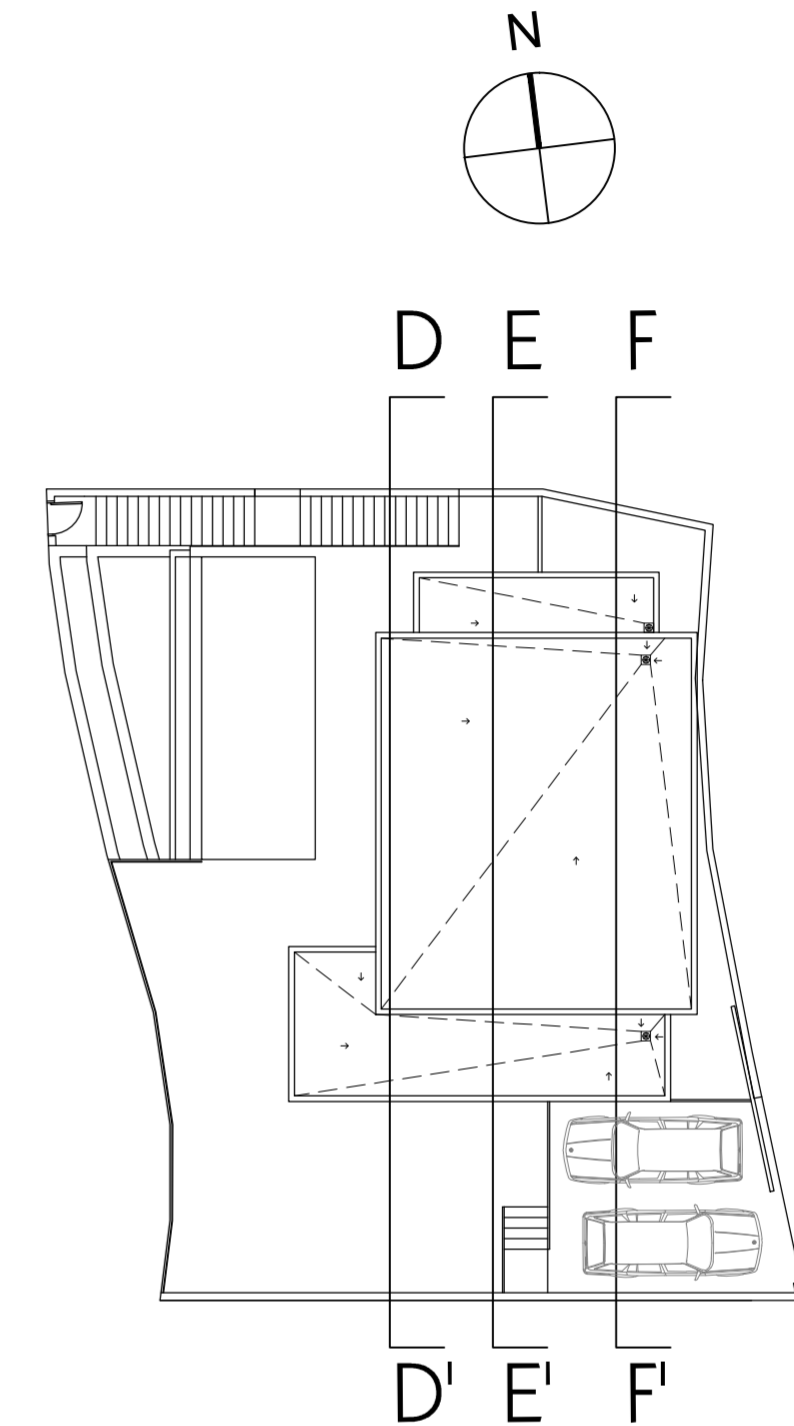

CUMBRE VILLAS

Amazing Villas, Stunning Views

+34 958 611 809

+34 647 881 853

sales@cumbrevillas.com

www.cumbrevillas.com

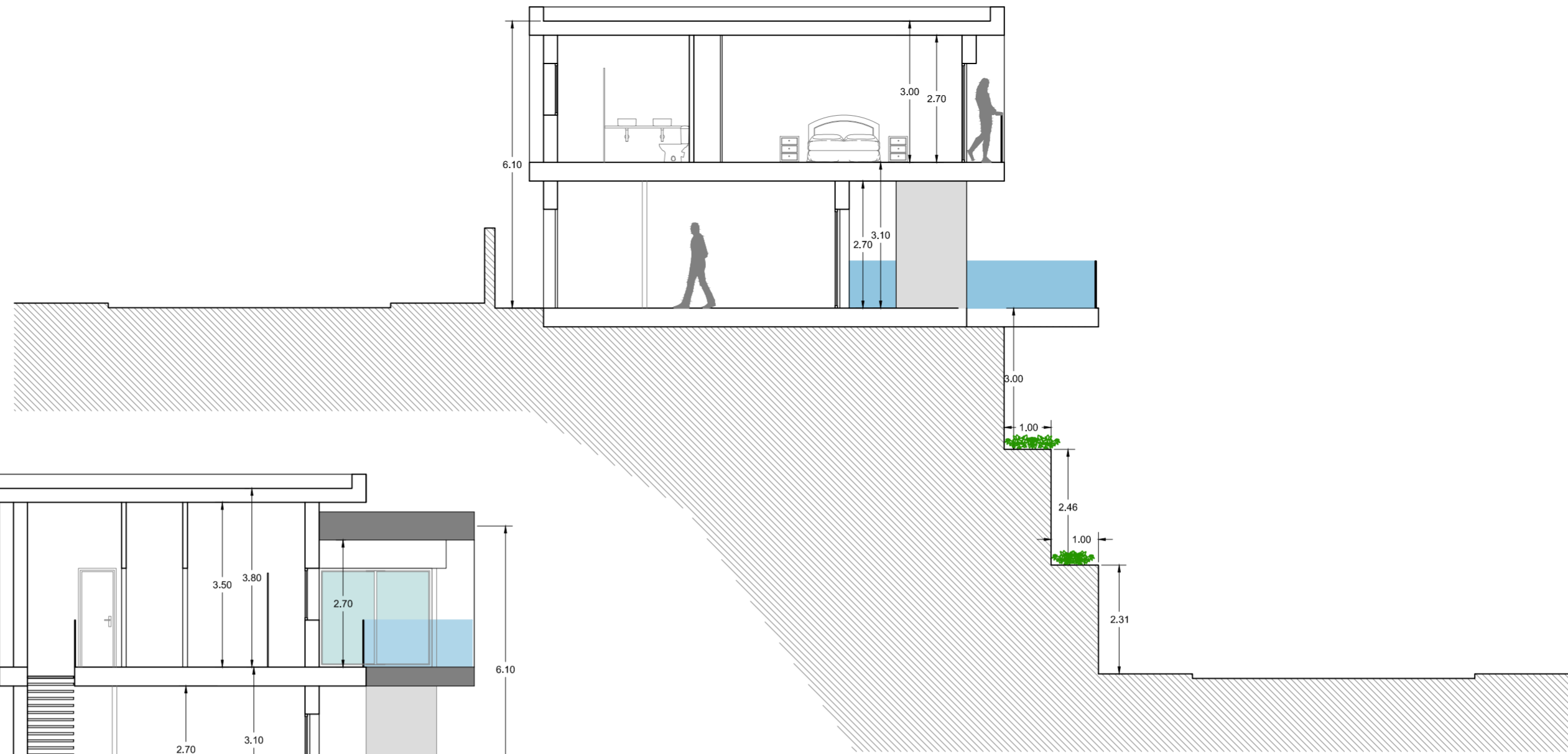
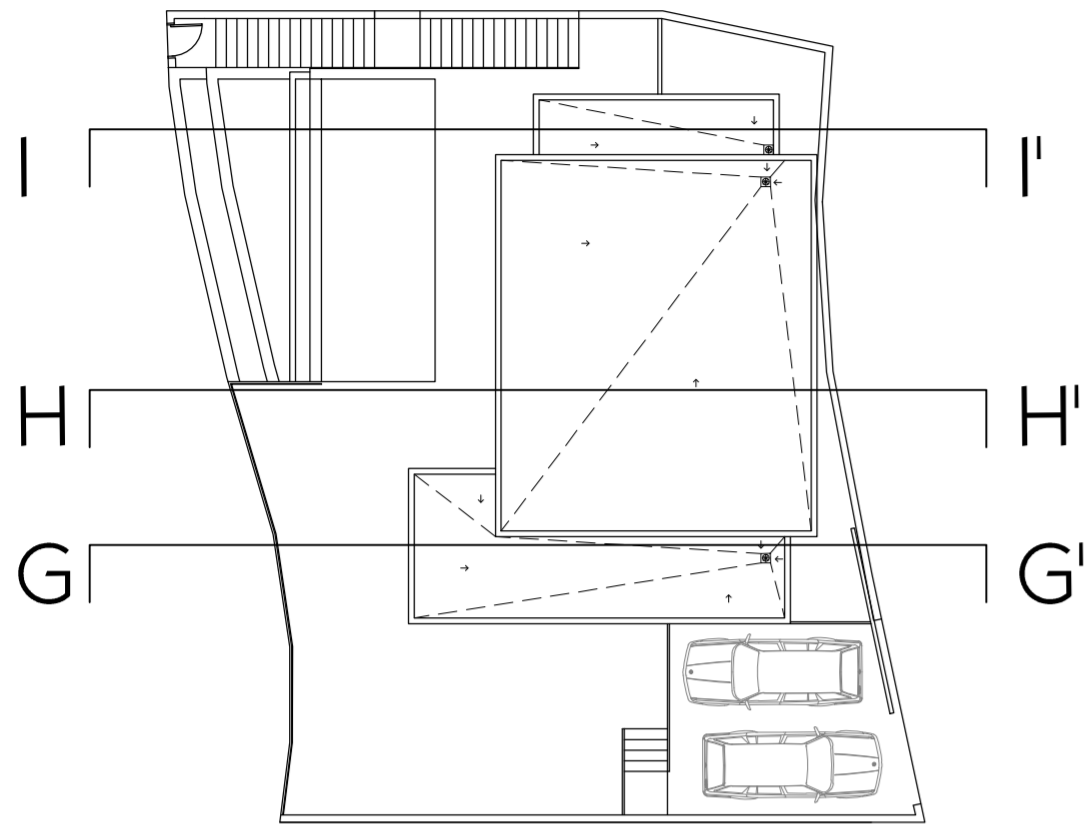
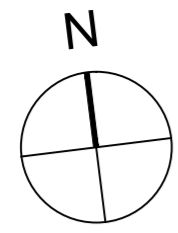

SECCION GG'

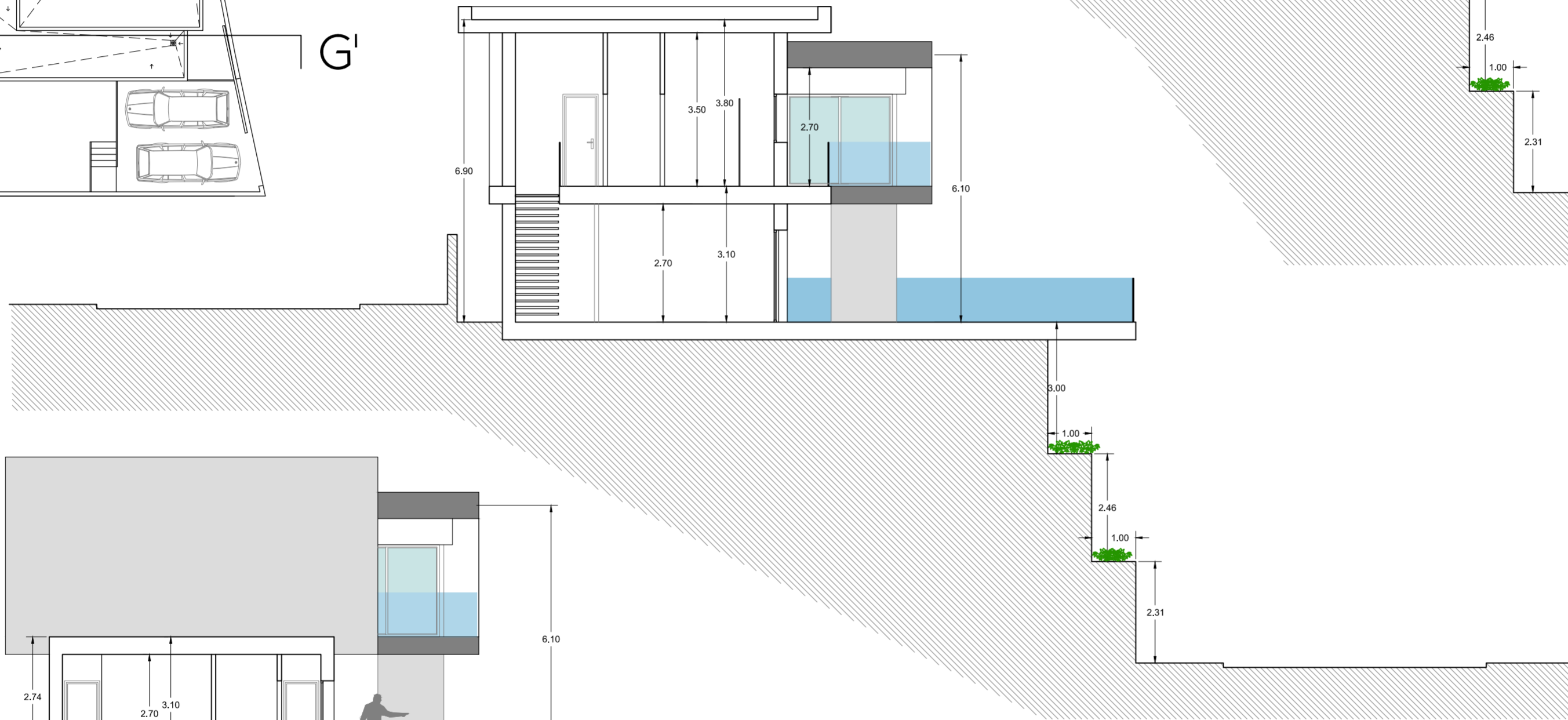

SECCION HH'

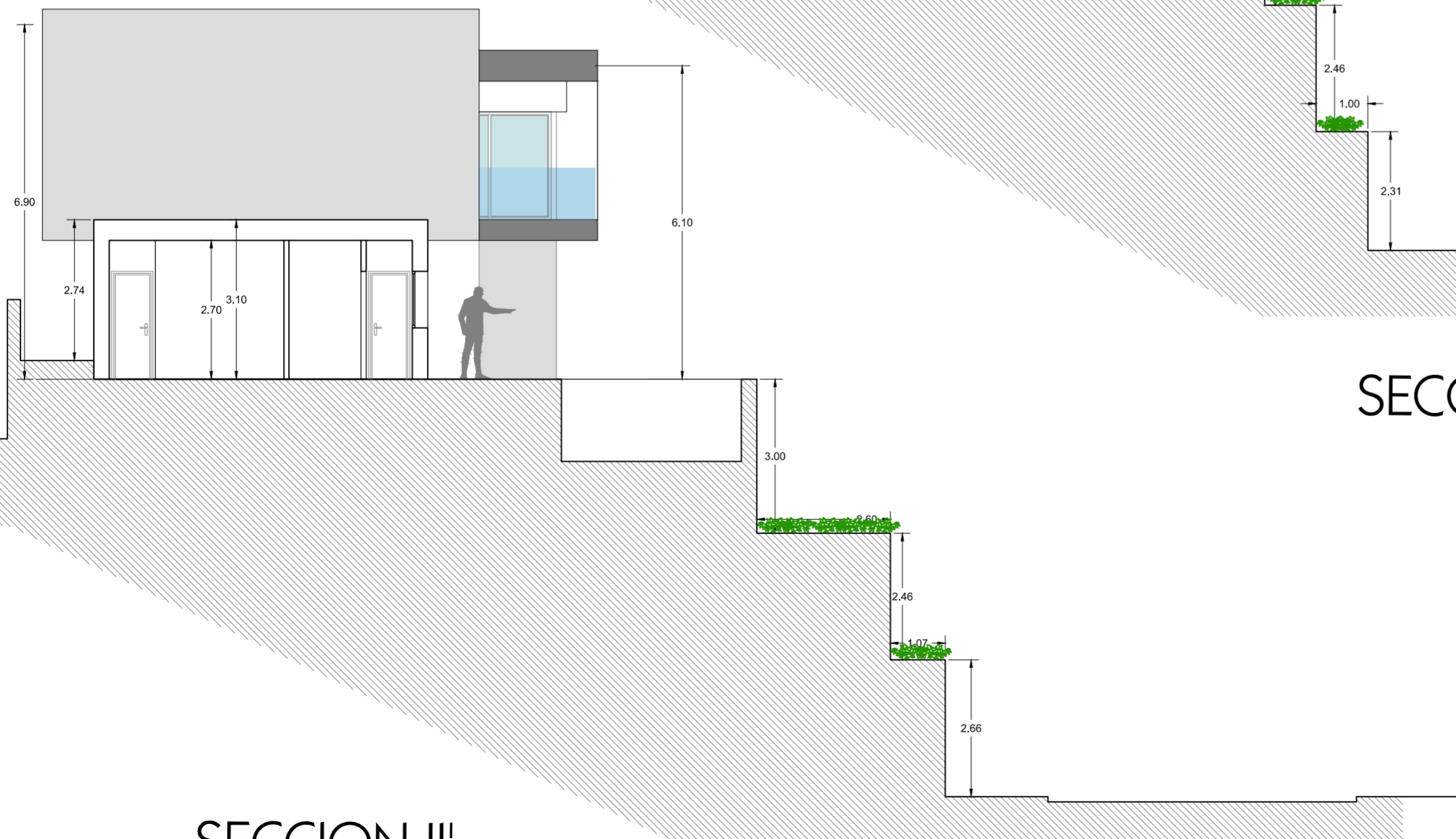

SECCION II'



CUMBRE VILLAS

Amazing Villas, Stunning Views

+34 958 611 809

+34 647 881 853

sales@cumbrevillas.com

www.cumbrevillas.com

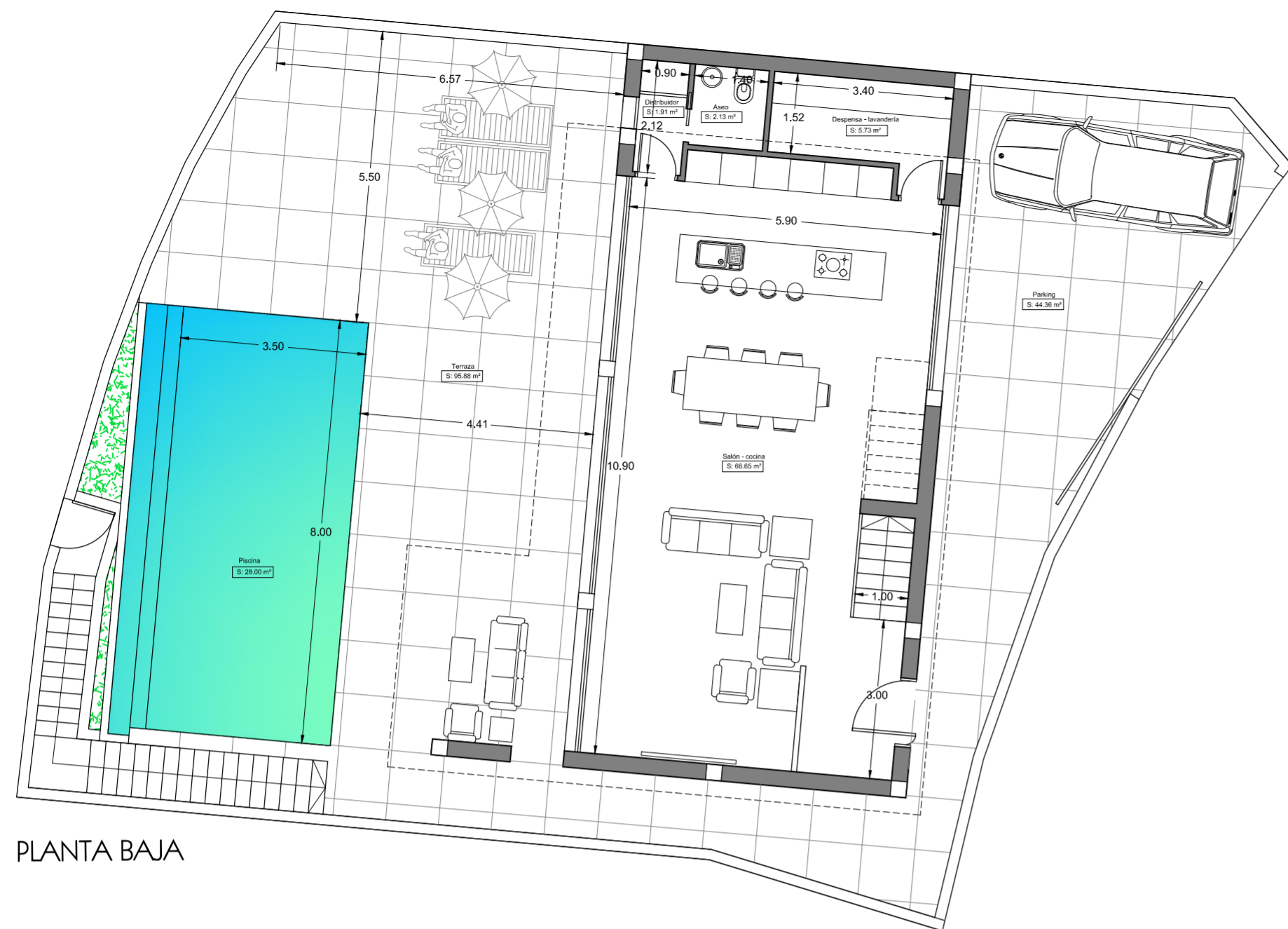

PLANTA BAJA

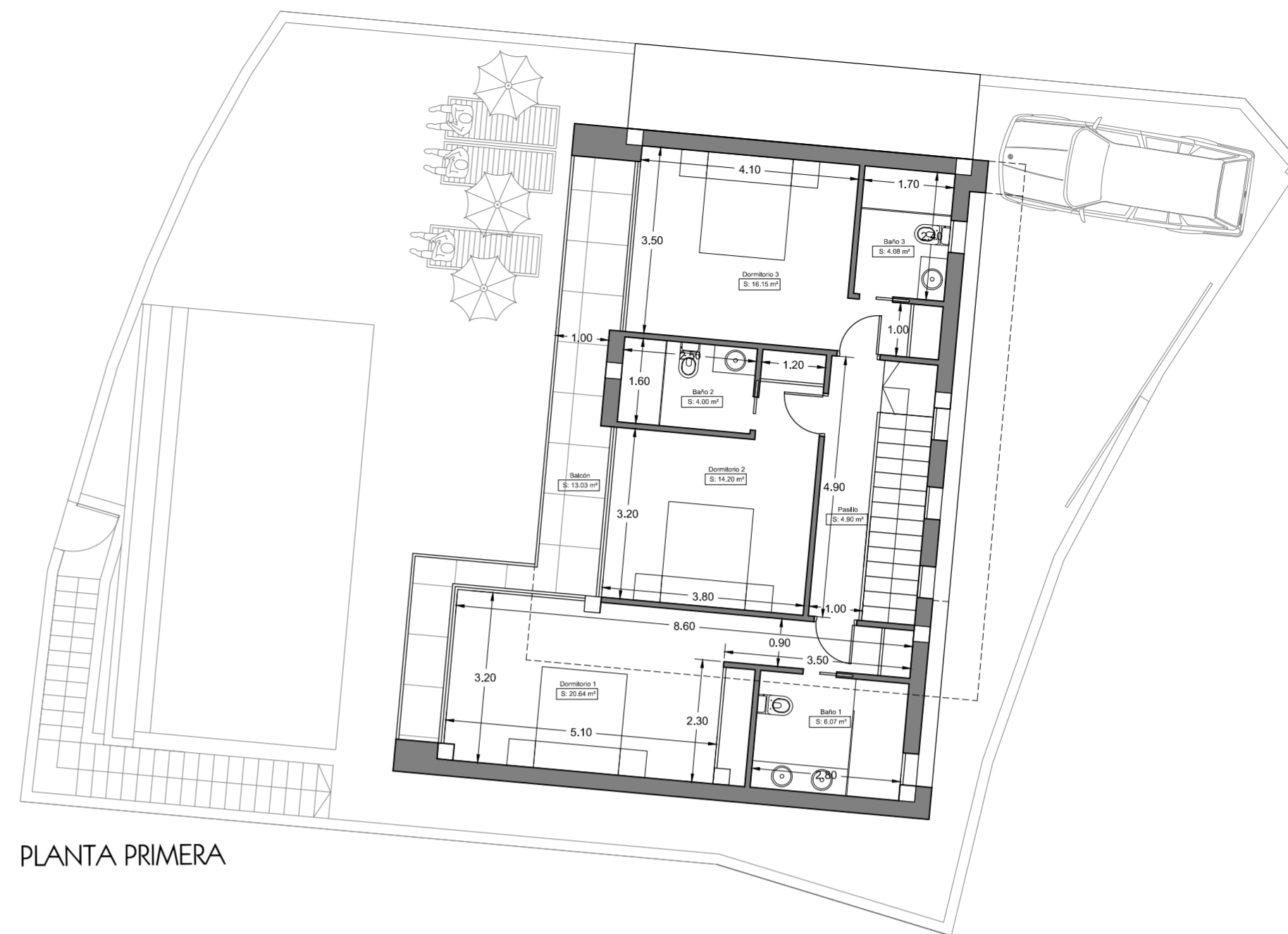

PLANTA PRIMERA

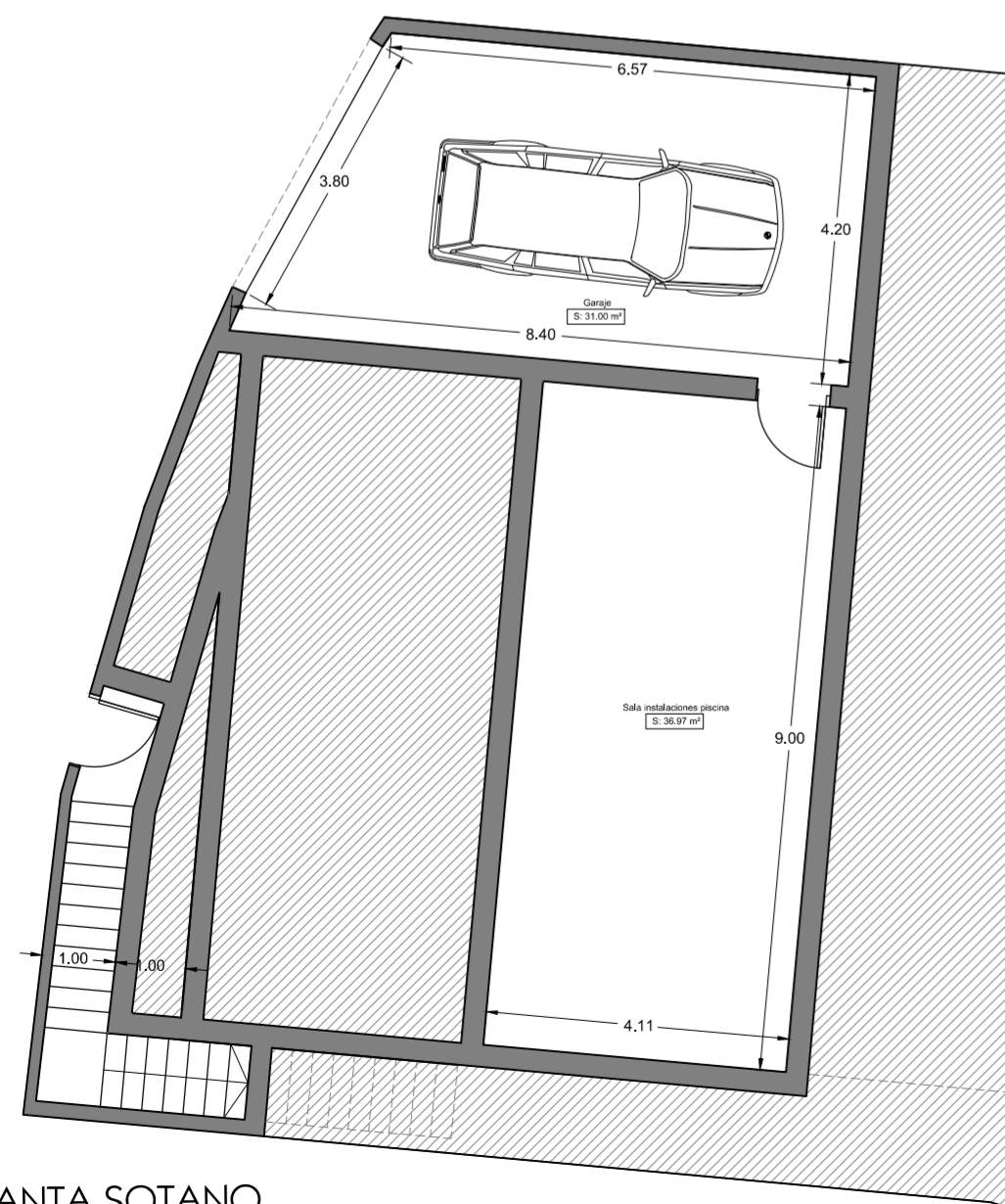

PLANTA SOTANO

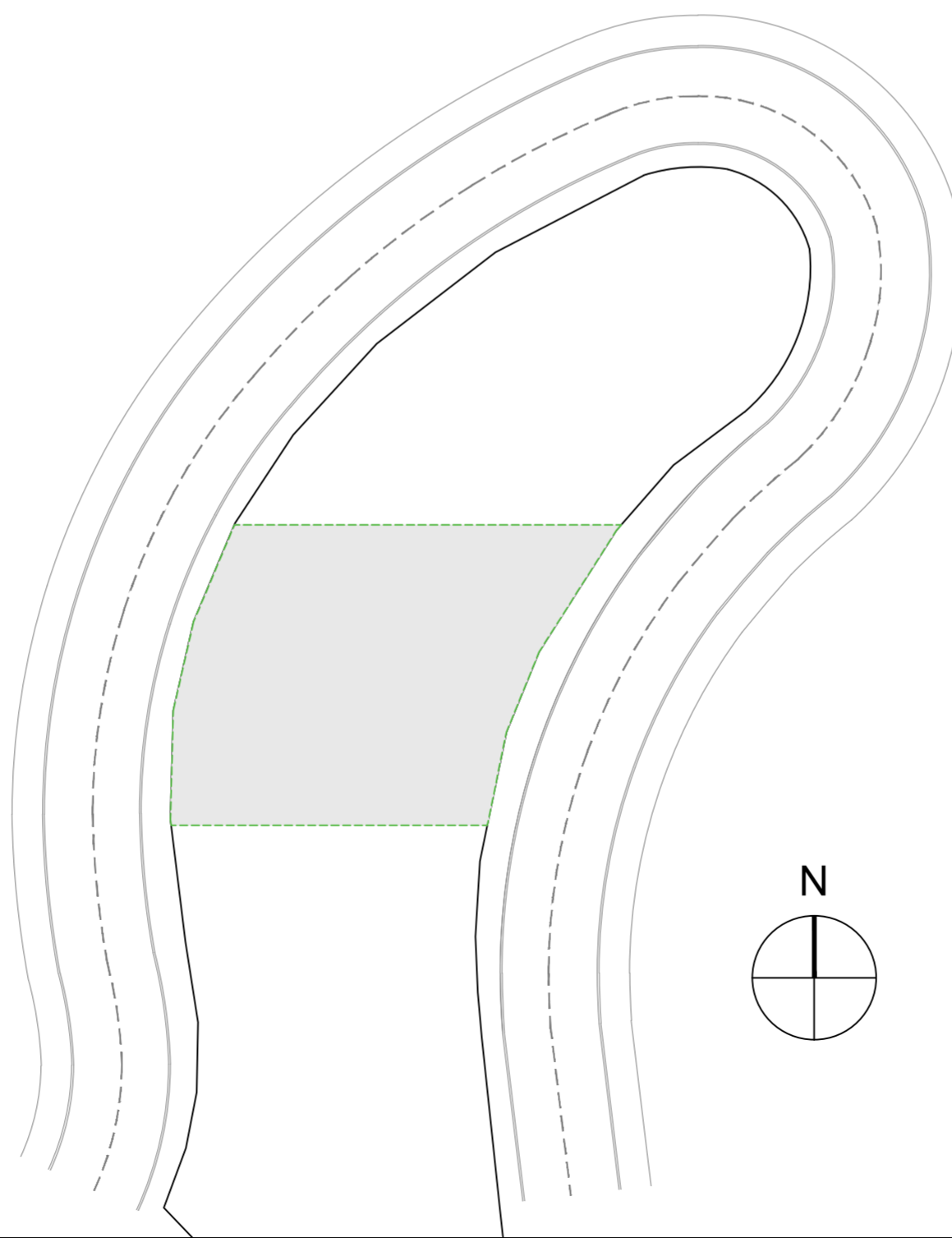

SUPERFICIES CONSTRUIDAS				
	PLANTA SÓTANO	PLANTA BAJA	PLANTA PRIMERA	TOTAL
VIVIENDA		100,09 m ²	91,14 m ²	191,23 m ²
GARAJE	36,60 m ²			36,60 m ²
PISCINA		28,00 m ²		28,00 m ²



CUMBRE VILLAS
Amazing Villas, Stunning Views

+34 958 611 809

+34 647 881 853

sales@cumbrevillas.com

www.cumbrevillas.com

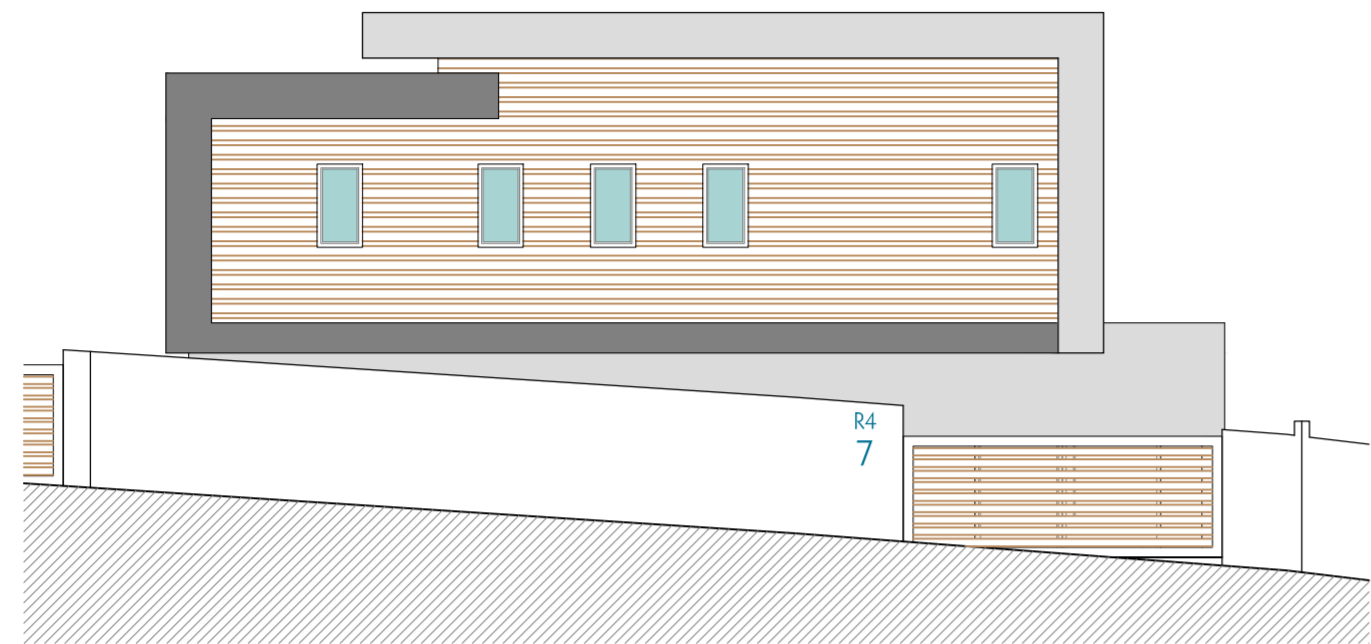

ALZADO ESTE

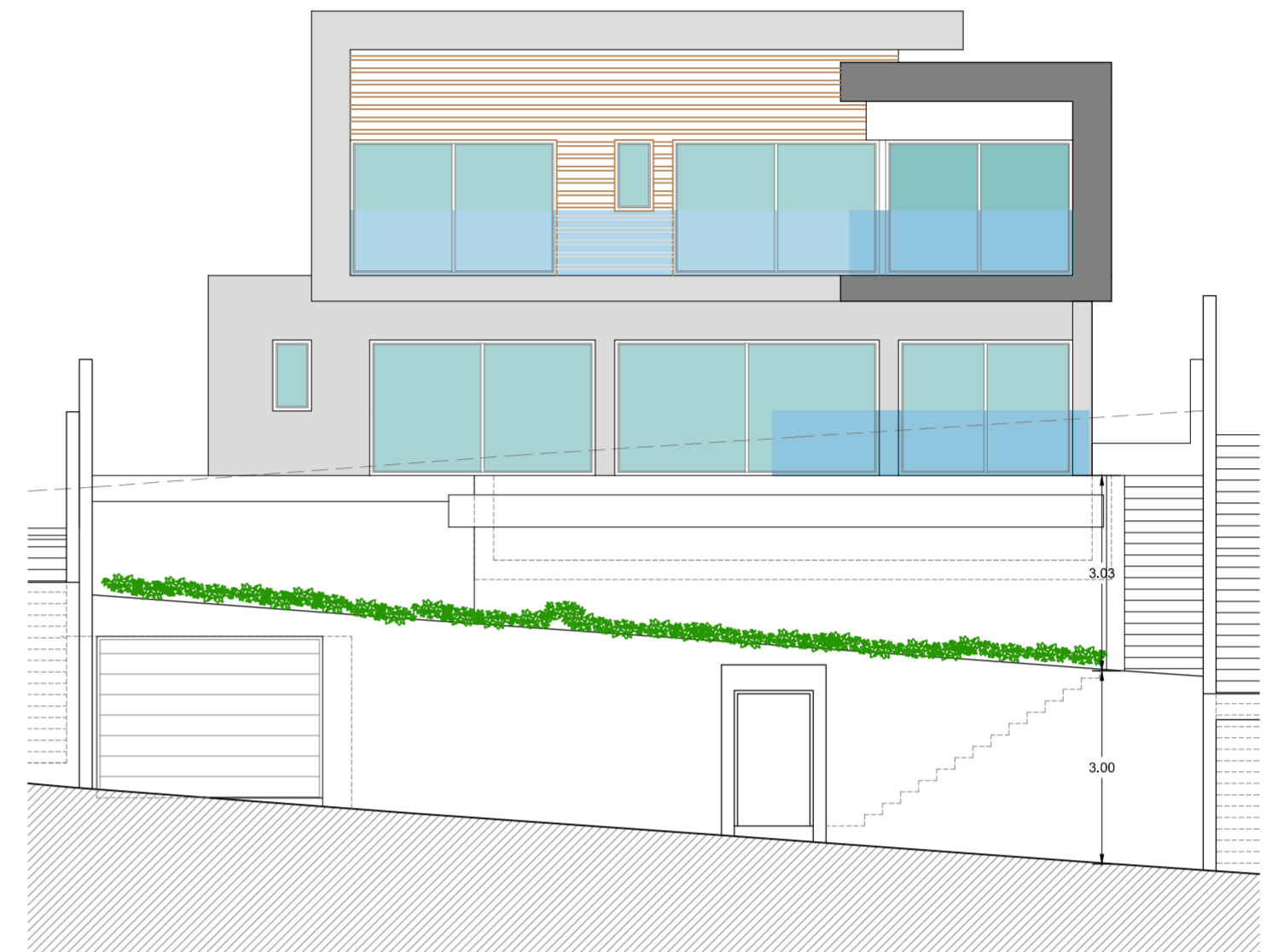

ALZADO OESTE

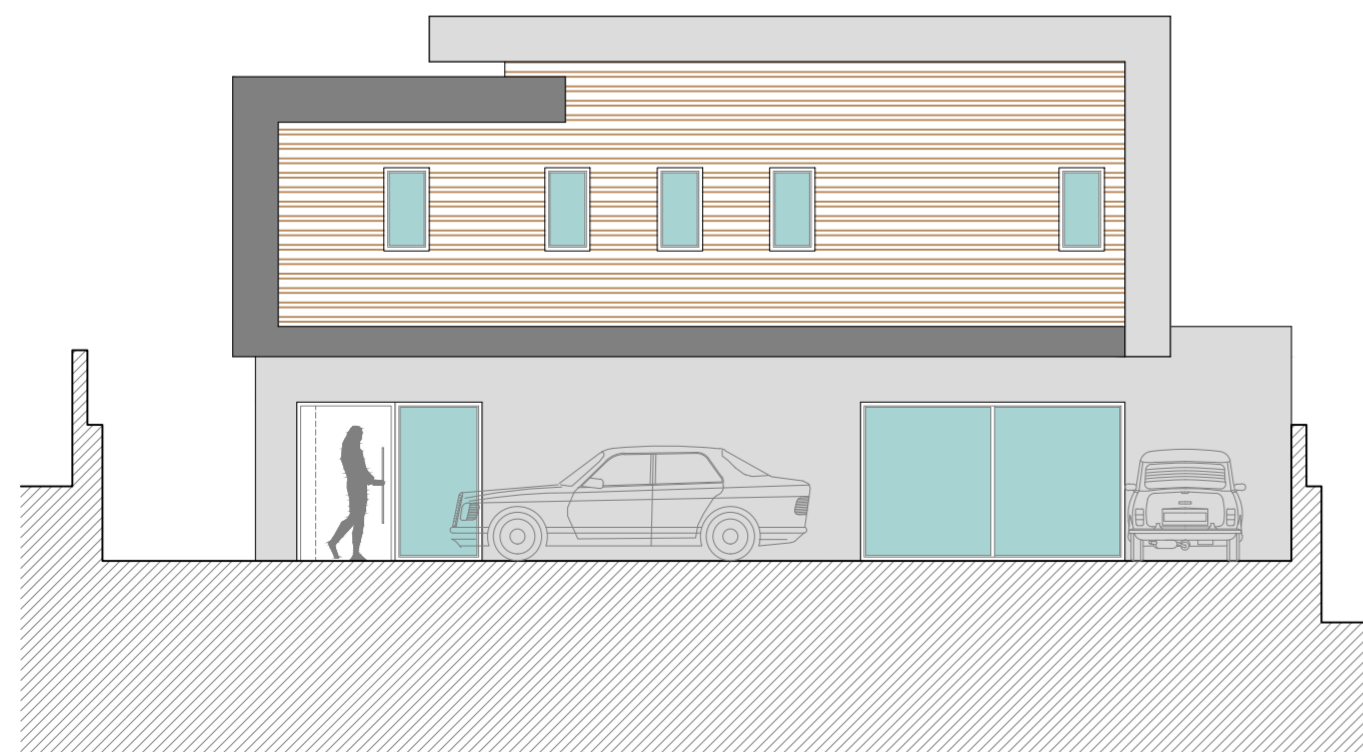

SECCION AA'

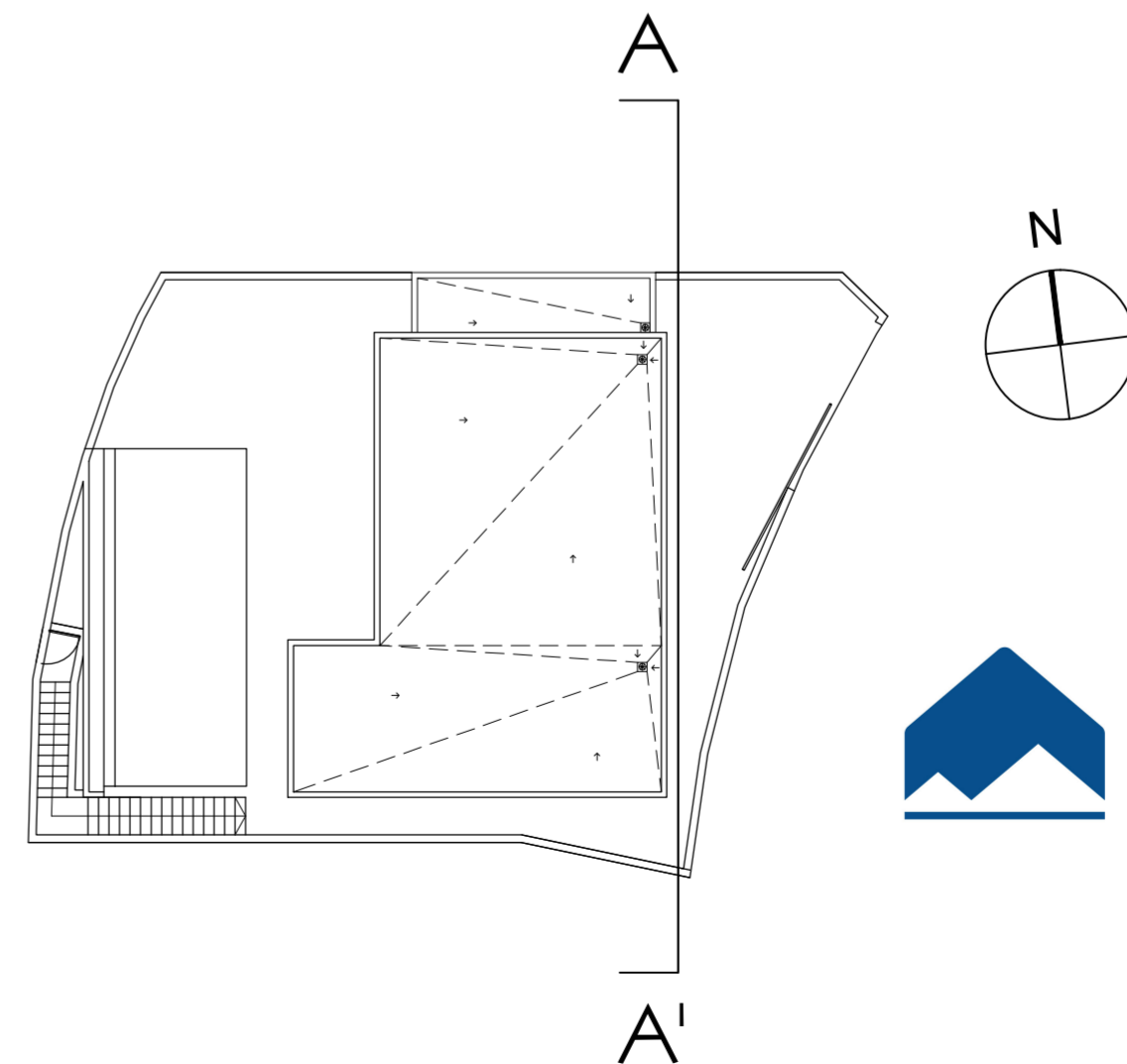

CUMBRE VILLAS

Amazing Villas, Stunning Views

+34 958 611 809

+34 647 881 853

sales@cumbrevillas.com

www.cumbrevillas.com

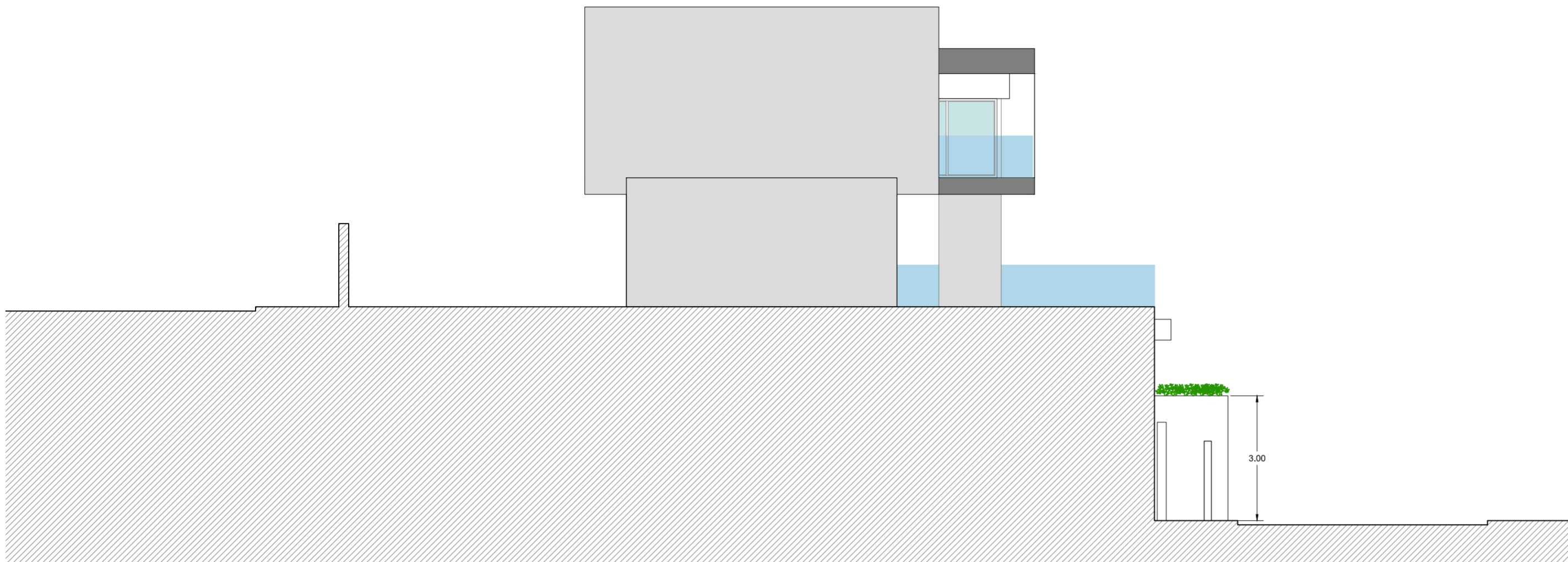

SECCION BB'

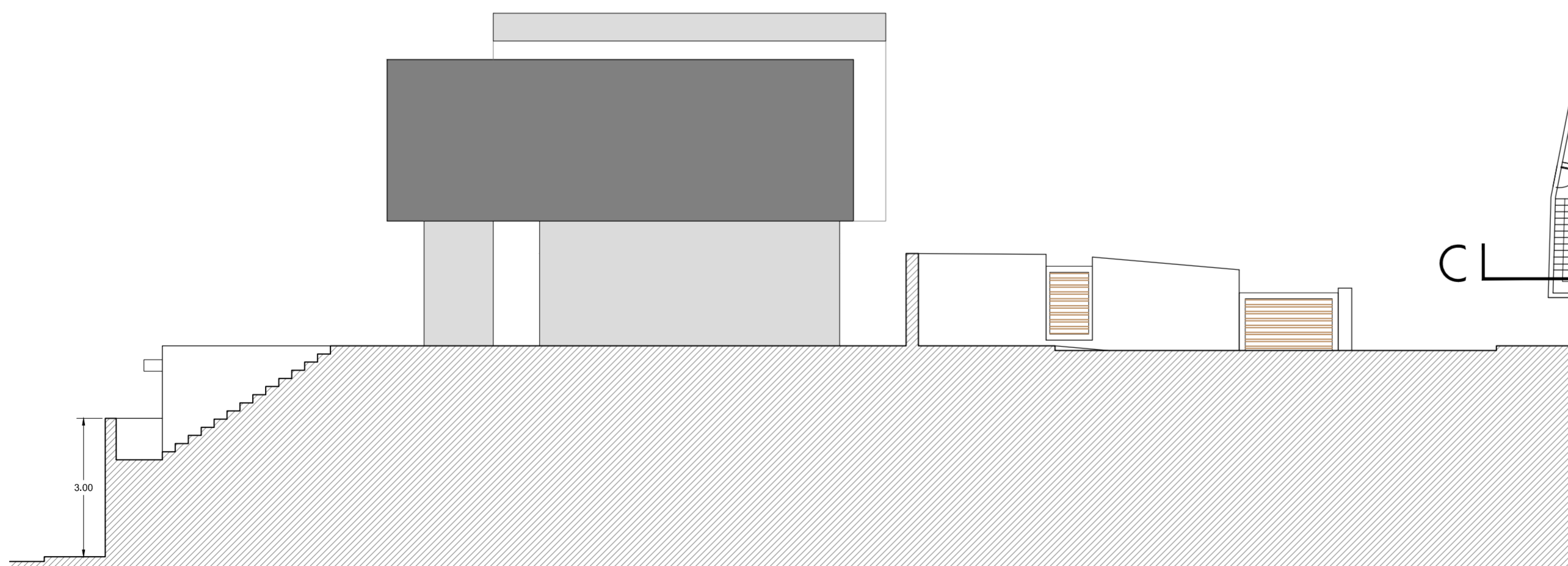

SECCION CC'

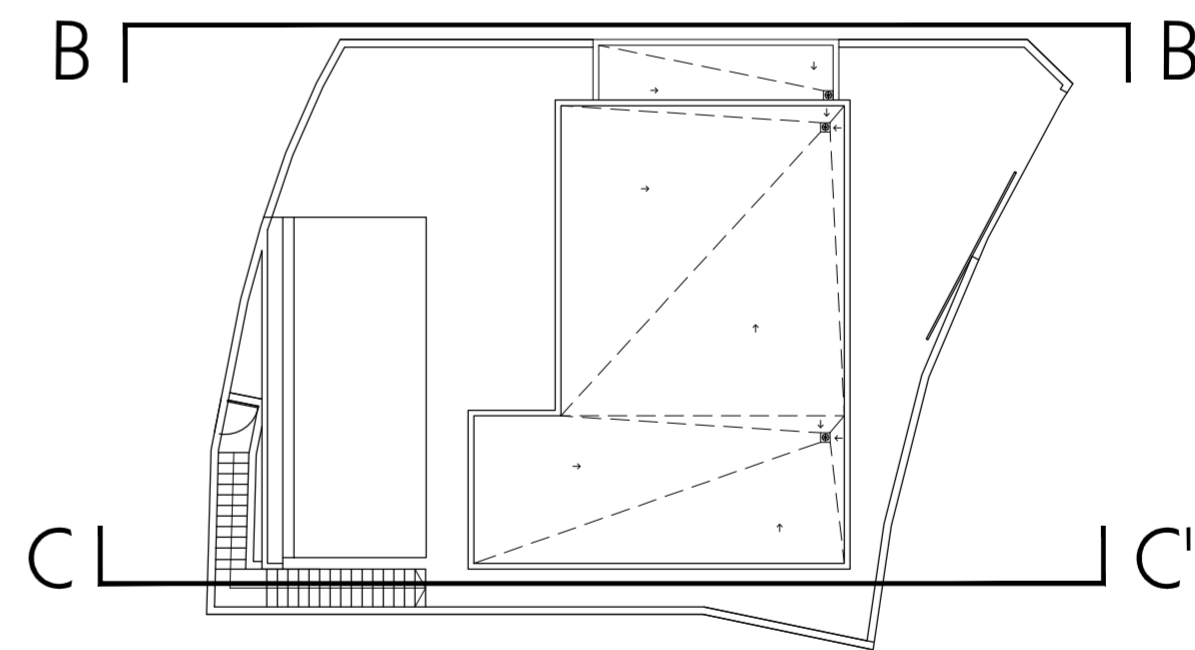

CUMBRE VILLAS

Amazing Villas, Stunning Views

+34 958 611 809

+34 647 881 853

sales@cumbrevillas.com

www.cumbrevillas.com

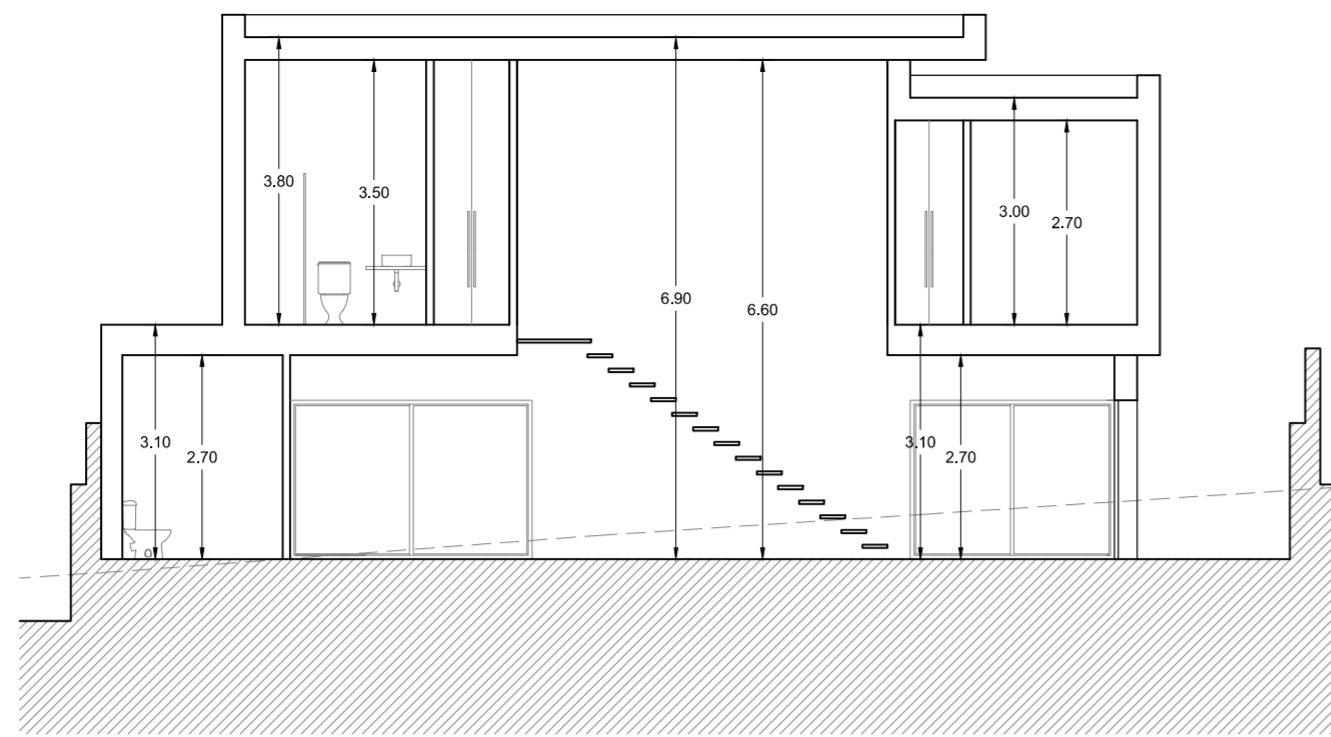

SECCION FF'

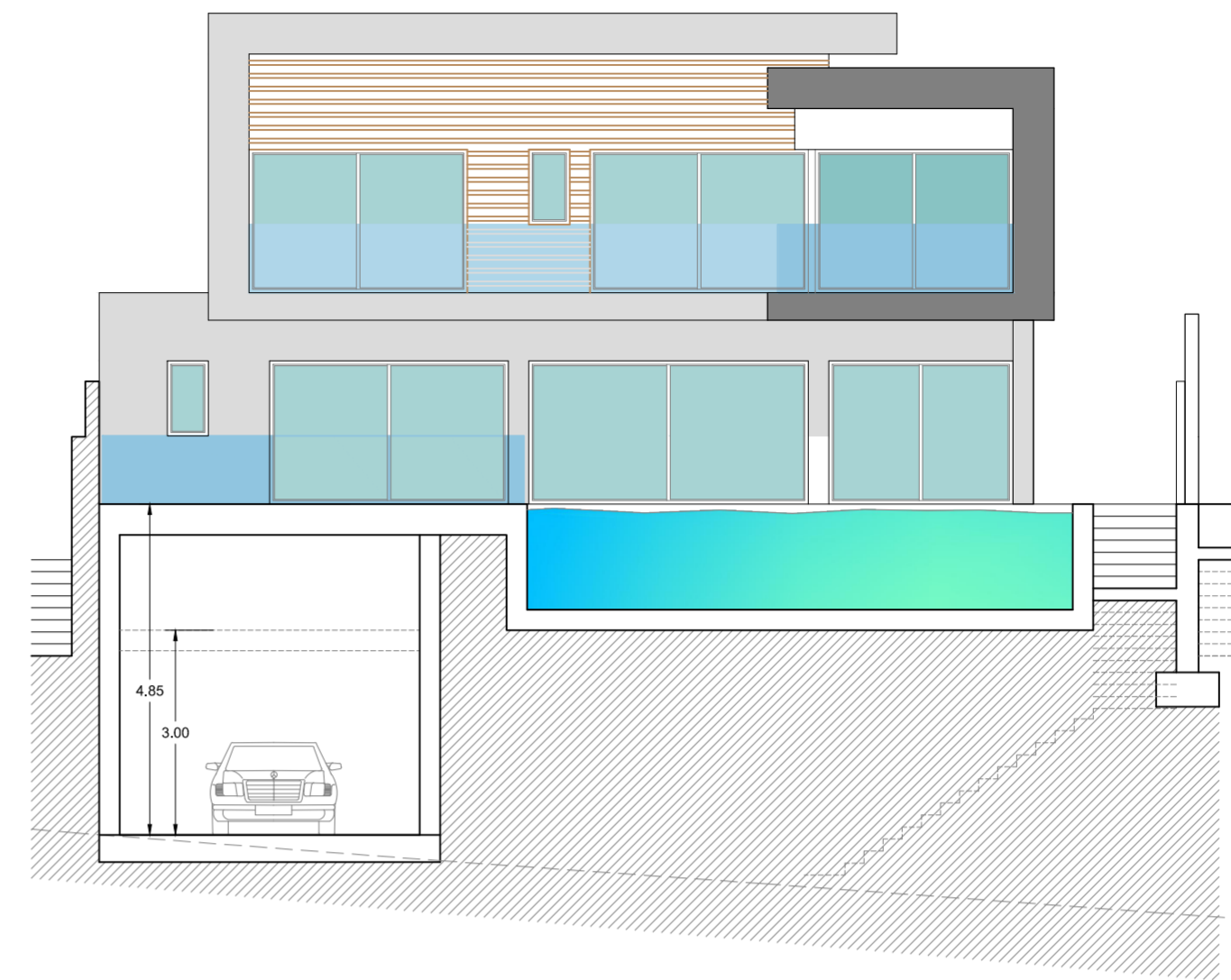

SECCION GG'

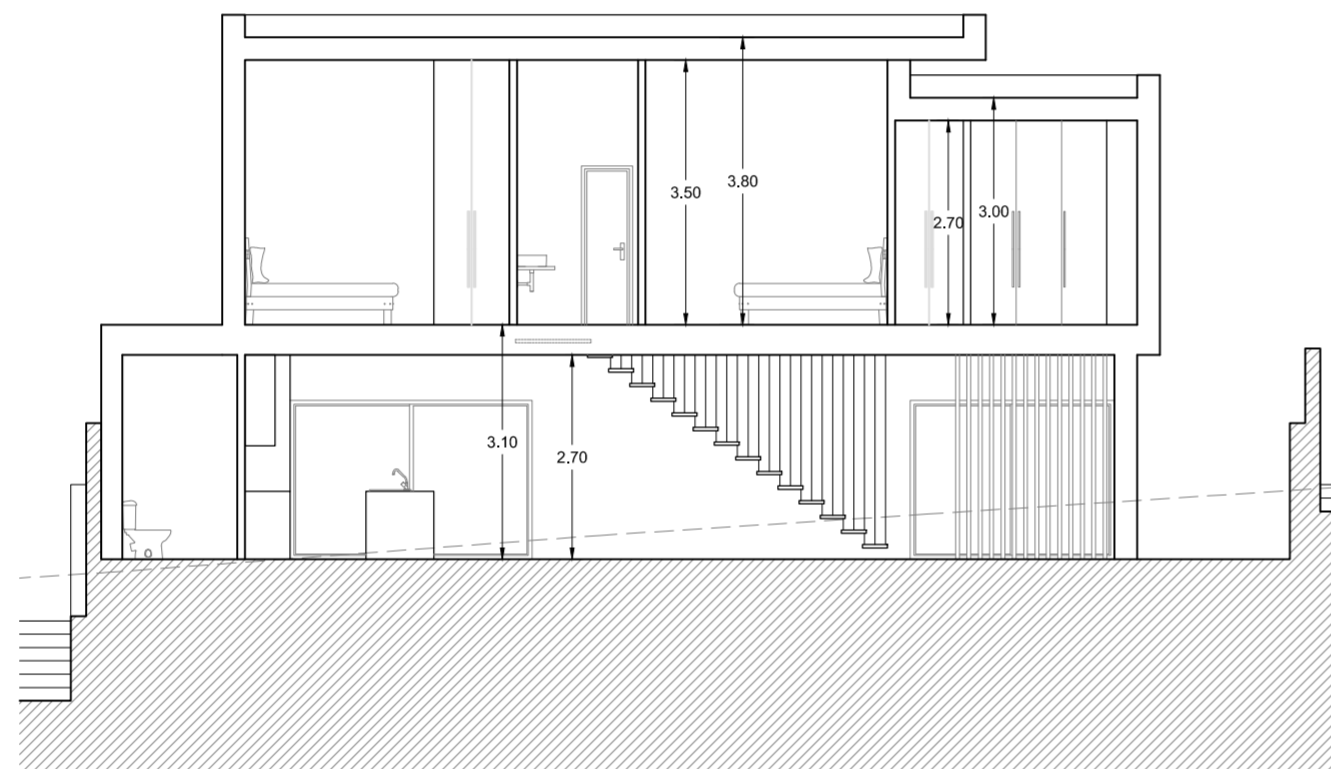

SECCION EE'

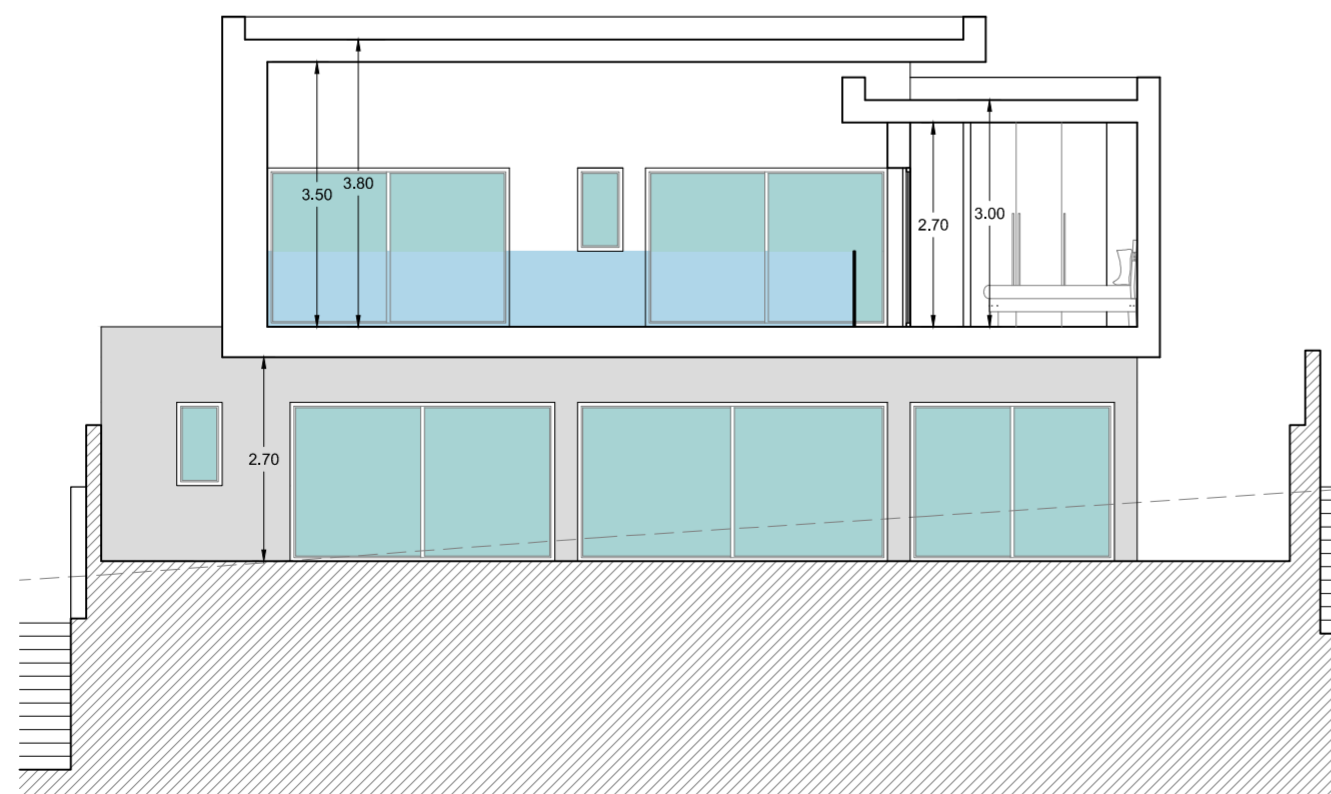

SECCION DD'

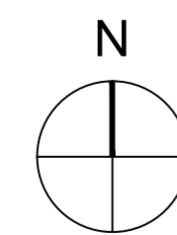
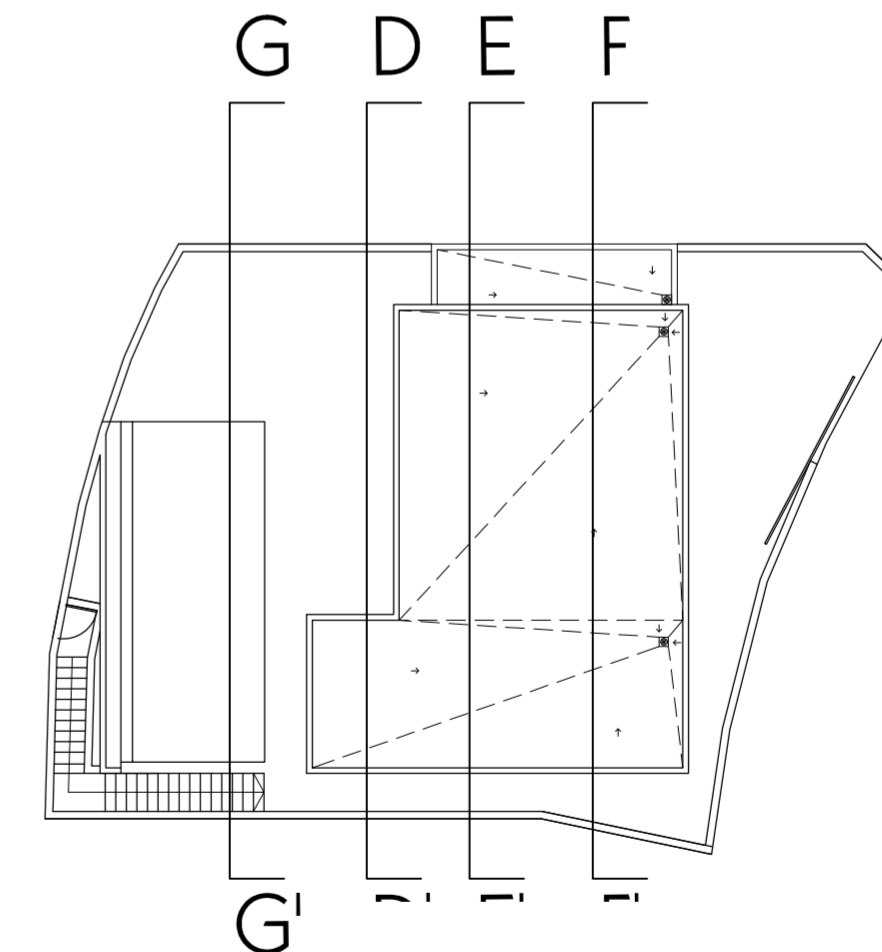

CUMBRE VILLAS
Amazing Villas, Stunning Views

+34 958 611 809

+34 647 881 853

sales@cumbrevillas.com

www.cumbrevillas.com

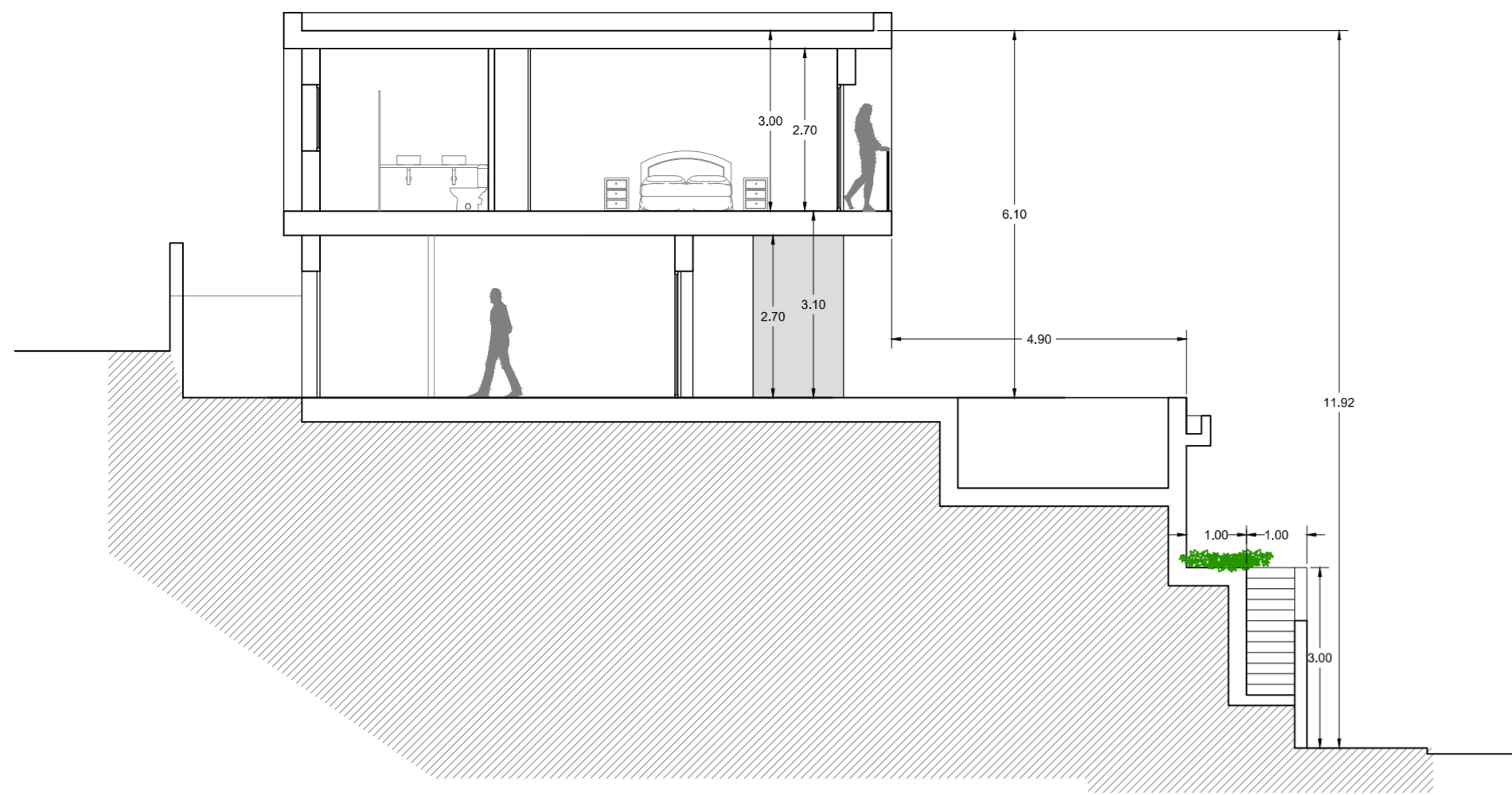

SECCION II''

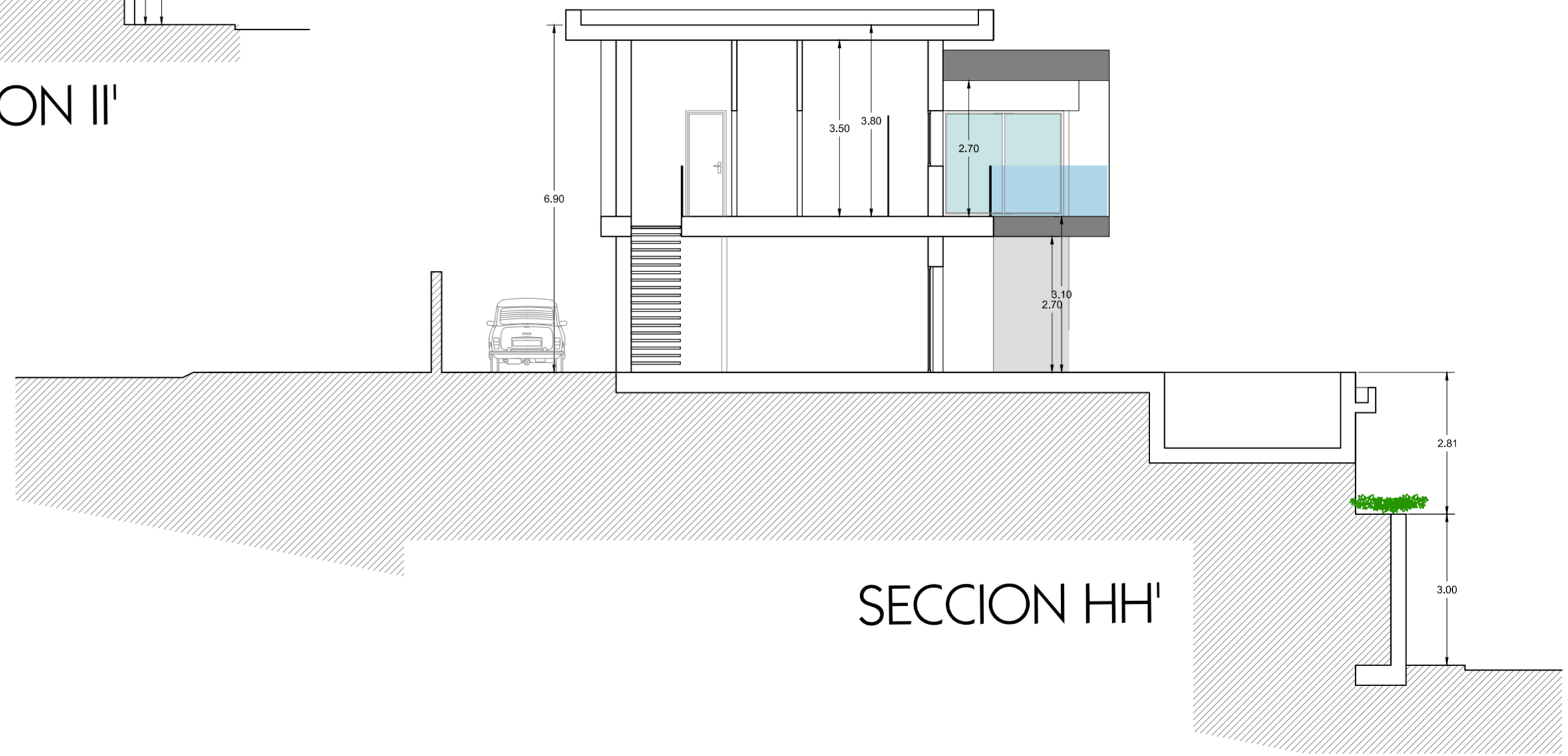
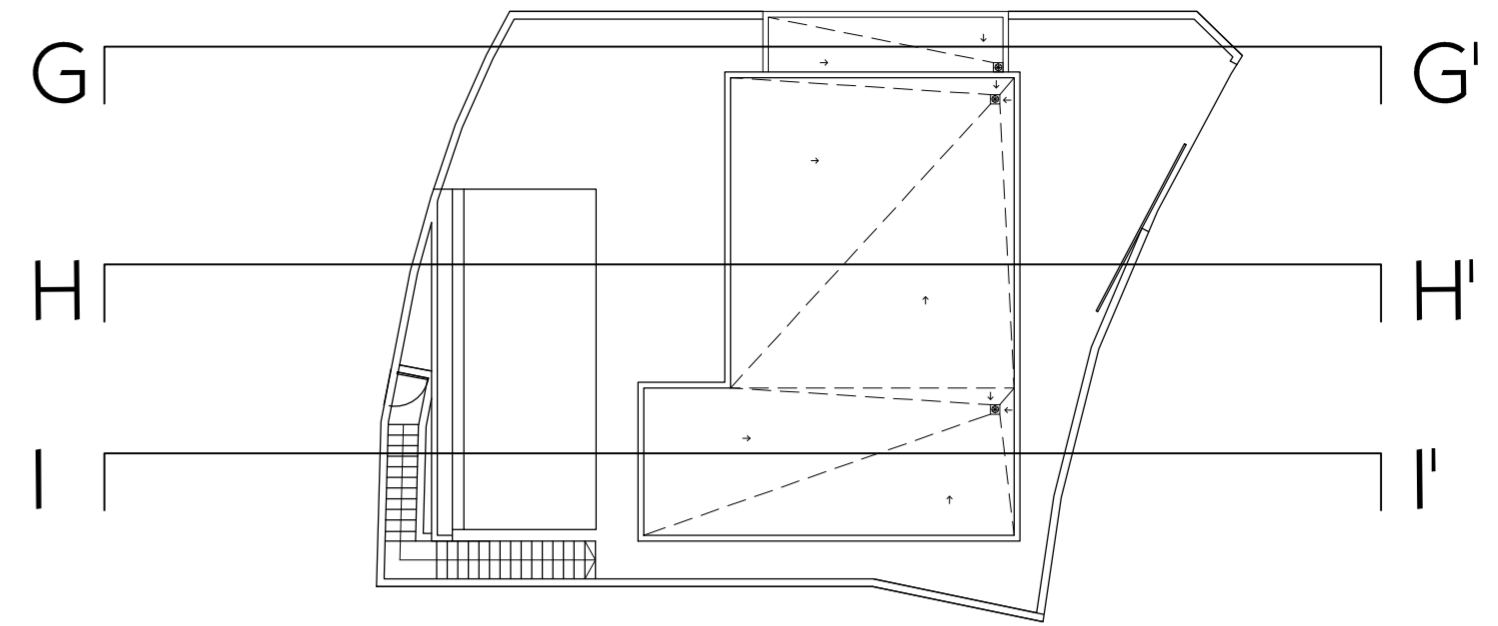

SECCION HH'

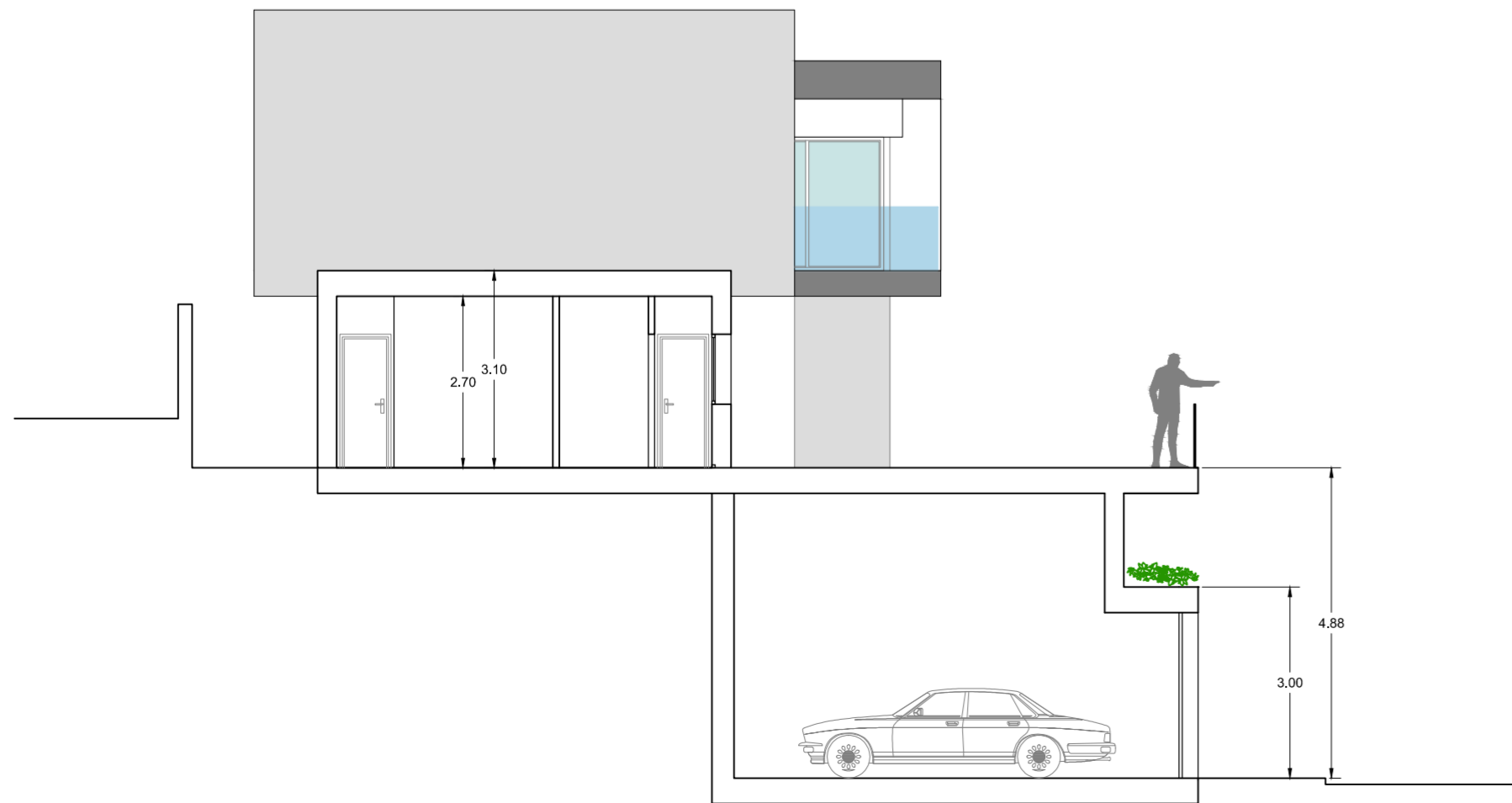

SECCION GG'



CUMBRE VILLAS

Amazing Villas, Stunning Views

+34 958 611 809

+34 647 881 853

sales@cumbrevillas.com

www.cumbrevillas.com

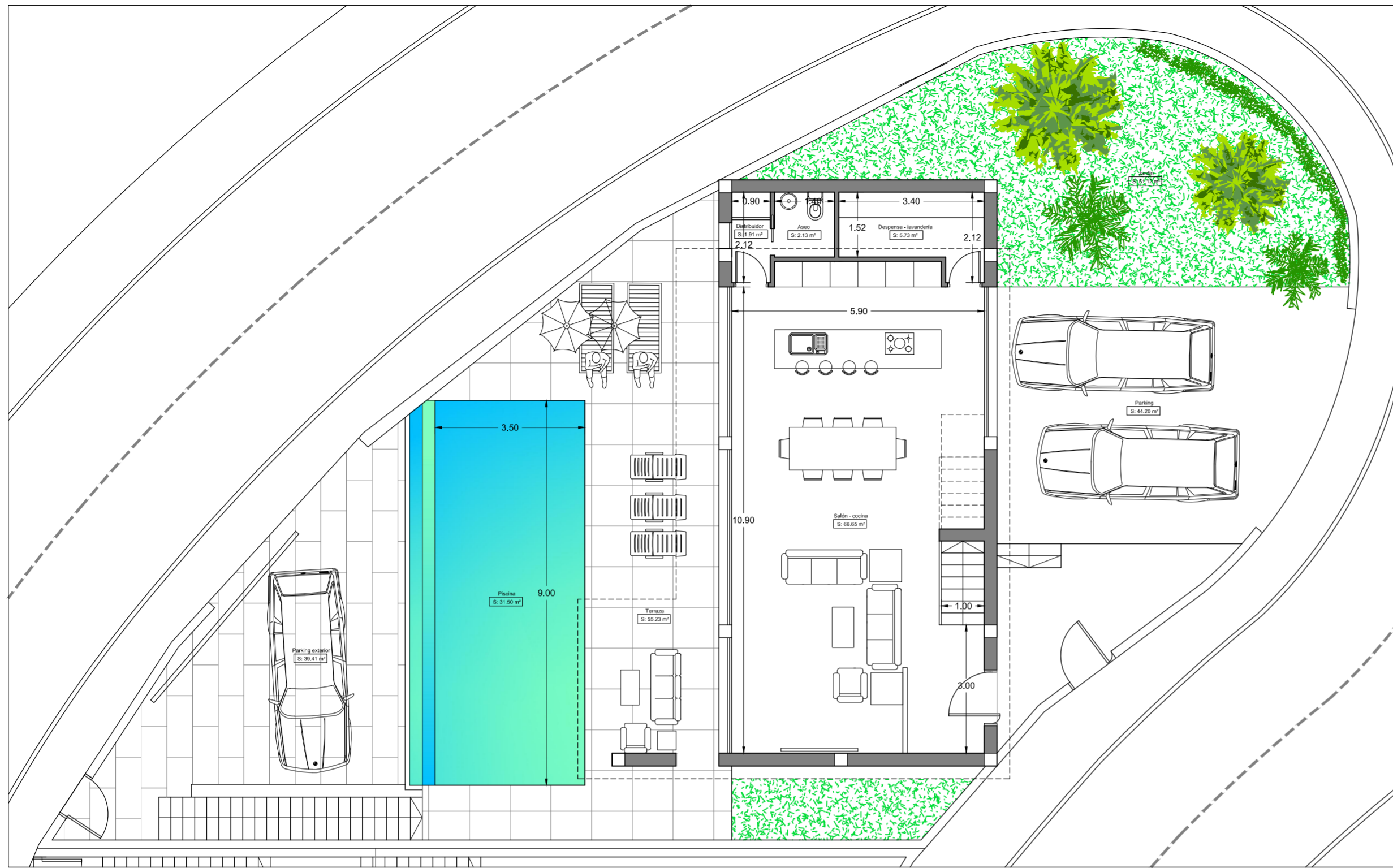

PLANTA BAJA

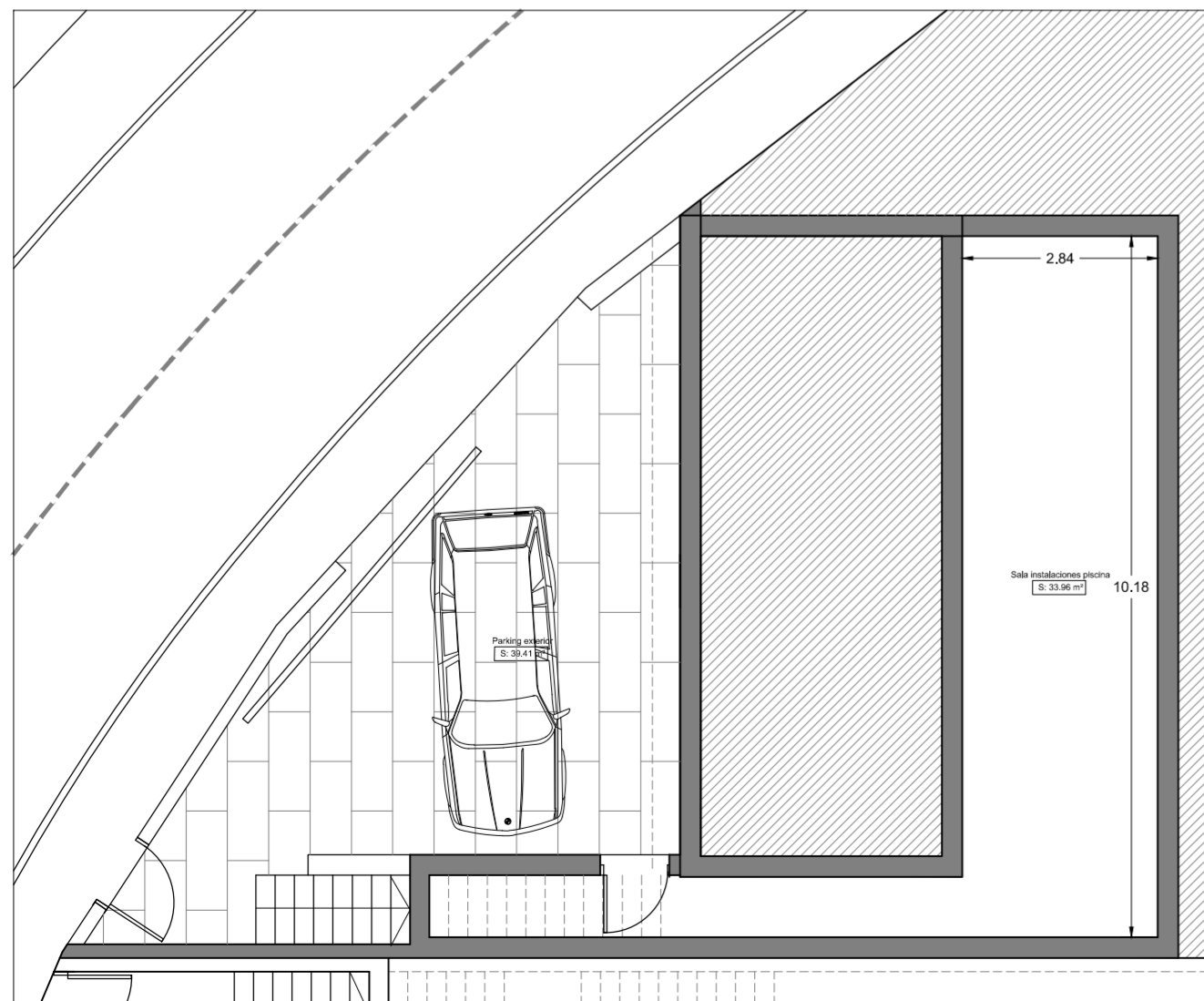

PLANTA SOTANO

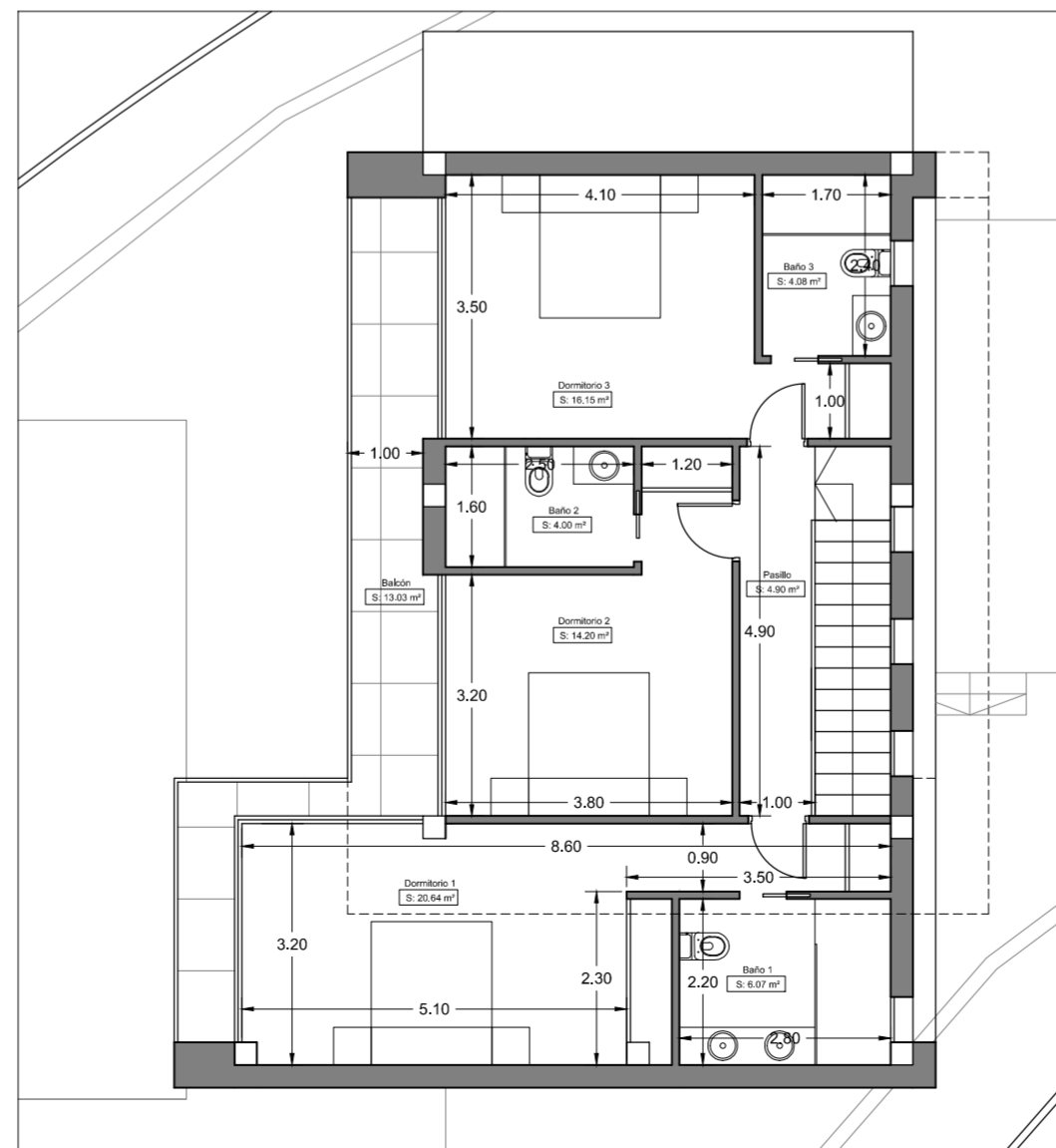

PLANTA PRIMERA

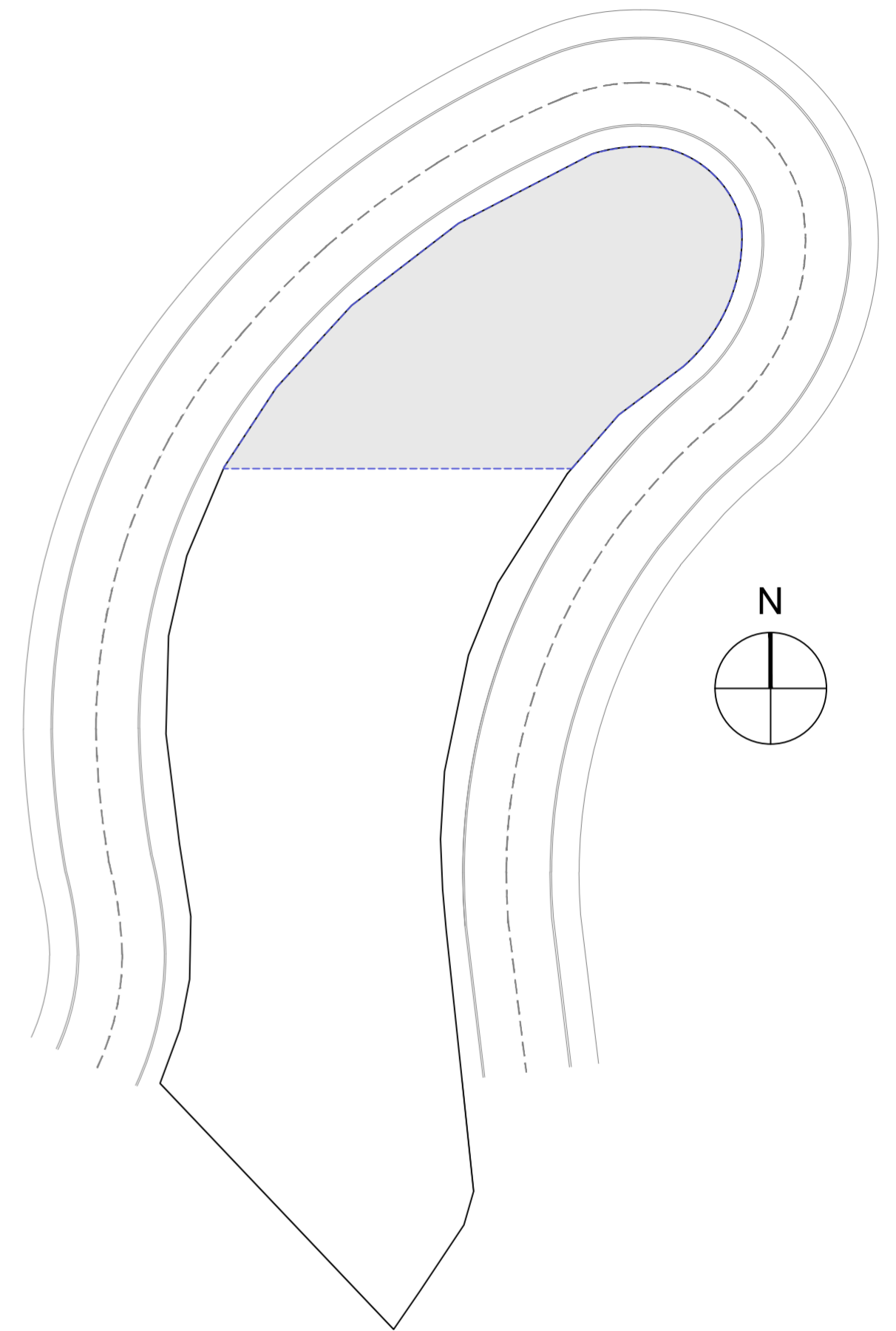

SUPERFICIES CONSTRUIDAS				
	PLANTA SÓTANO	PLANTA BAJA	PLANTA PRIMERA	TOTAL
VIVIENDA		100,09 m2	91,14 m2	191,23 m2
GARAJE				
PISCINA		31,50 m2		31,50 m2



CUMBRE VILLAS
Amazing Villas, Stunning Views

+34 958 611 809

+34 647 881 853

sales@cumbrevillas.com

www.cumbrevillas.com

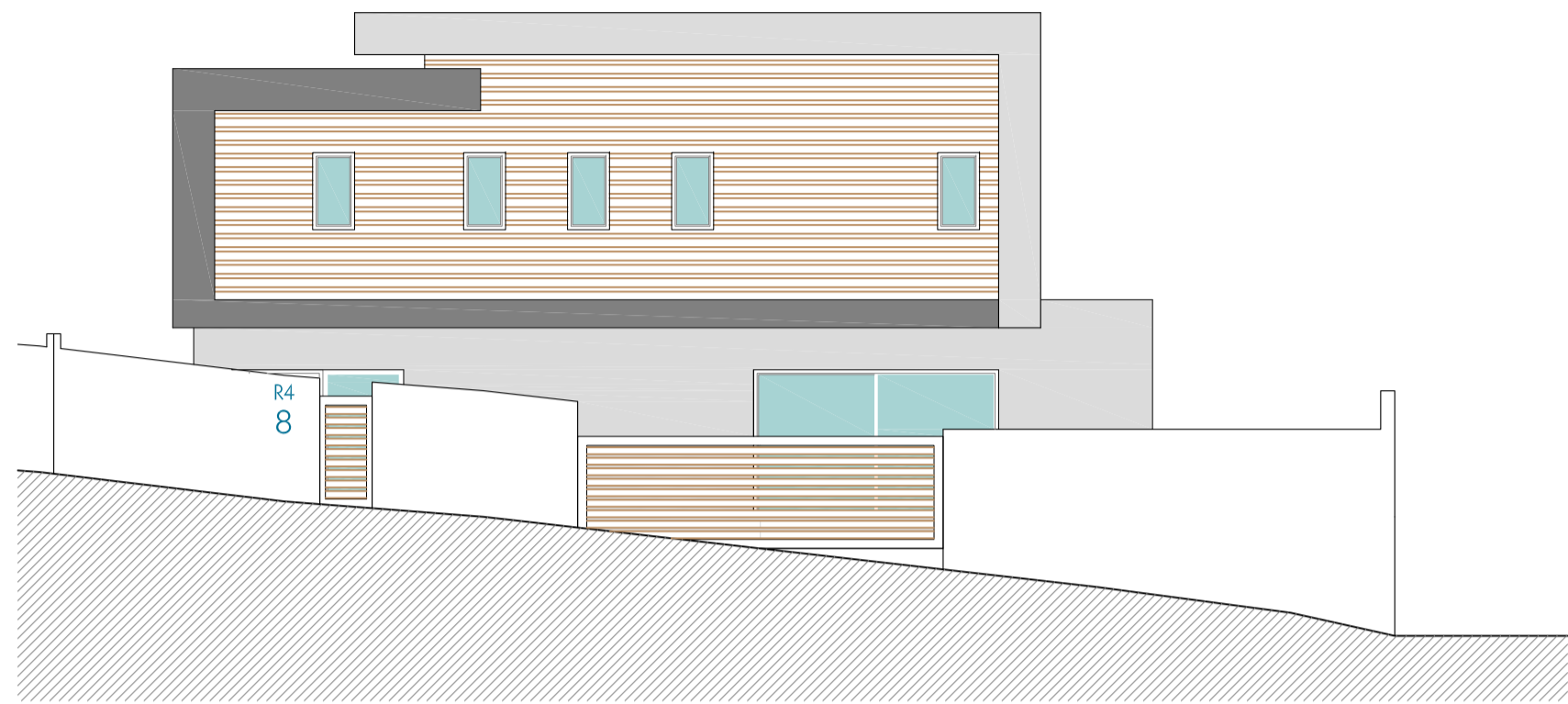

ALZADO ESTE

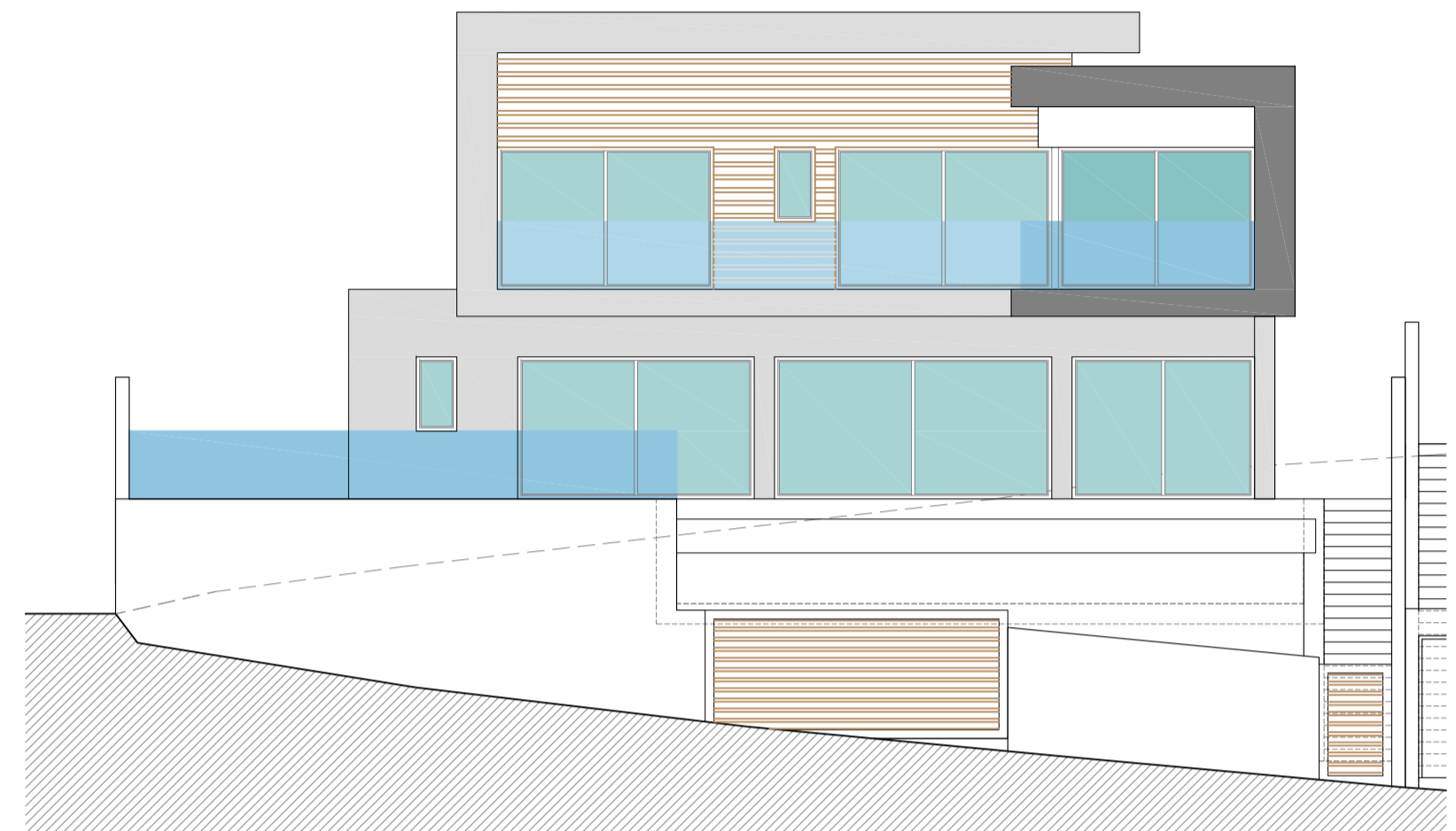

ALZADO OESTE

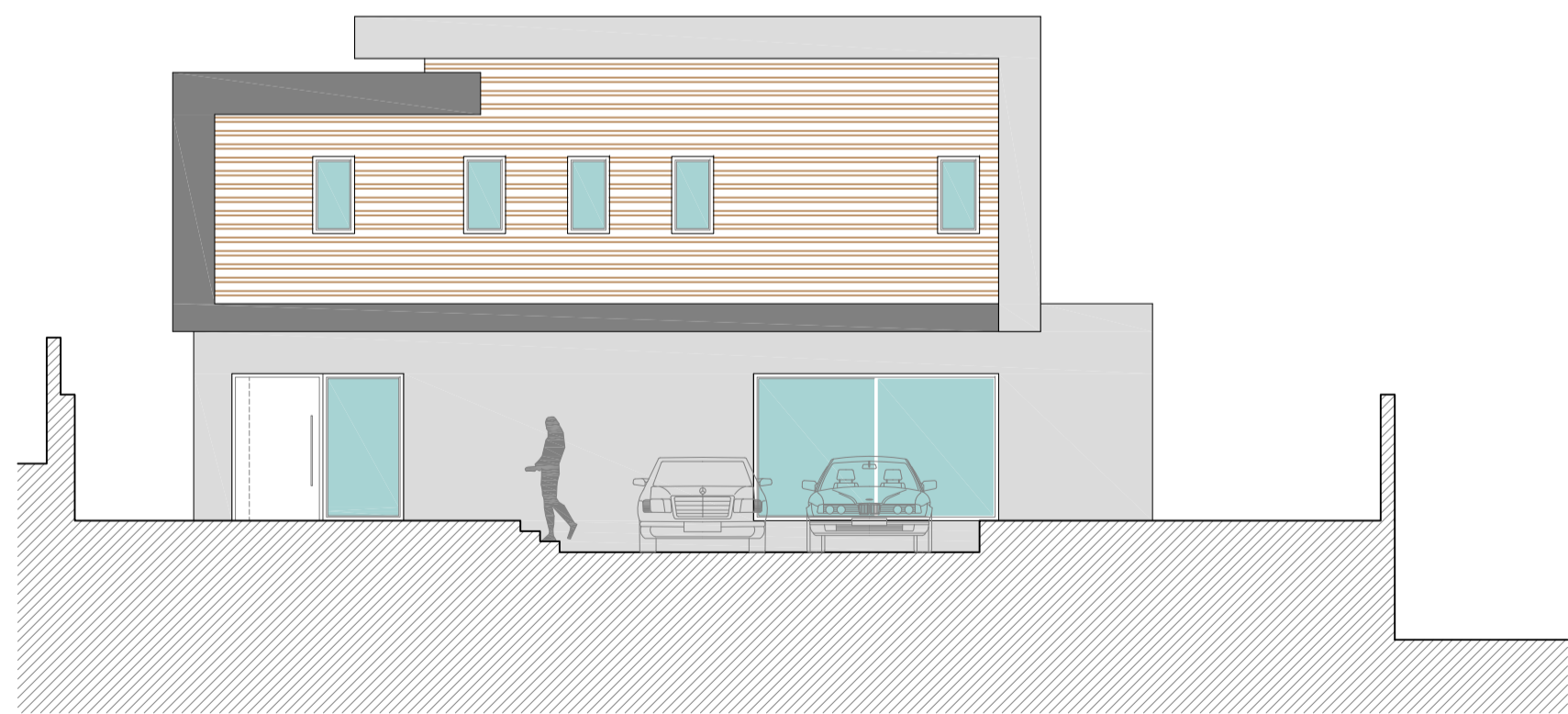

SECCION AA'

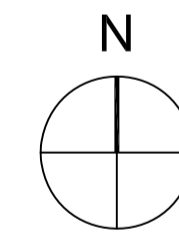
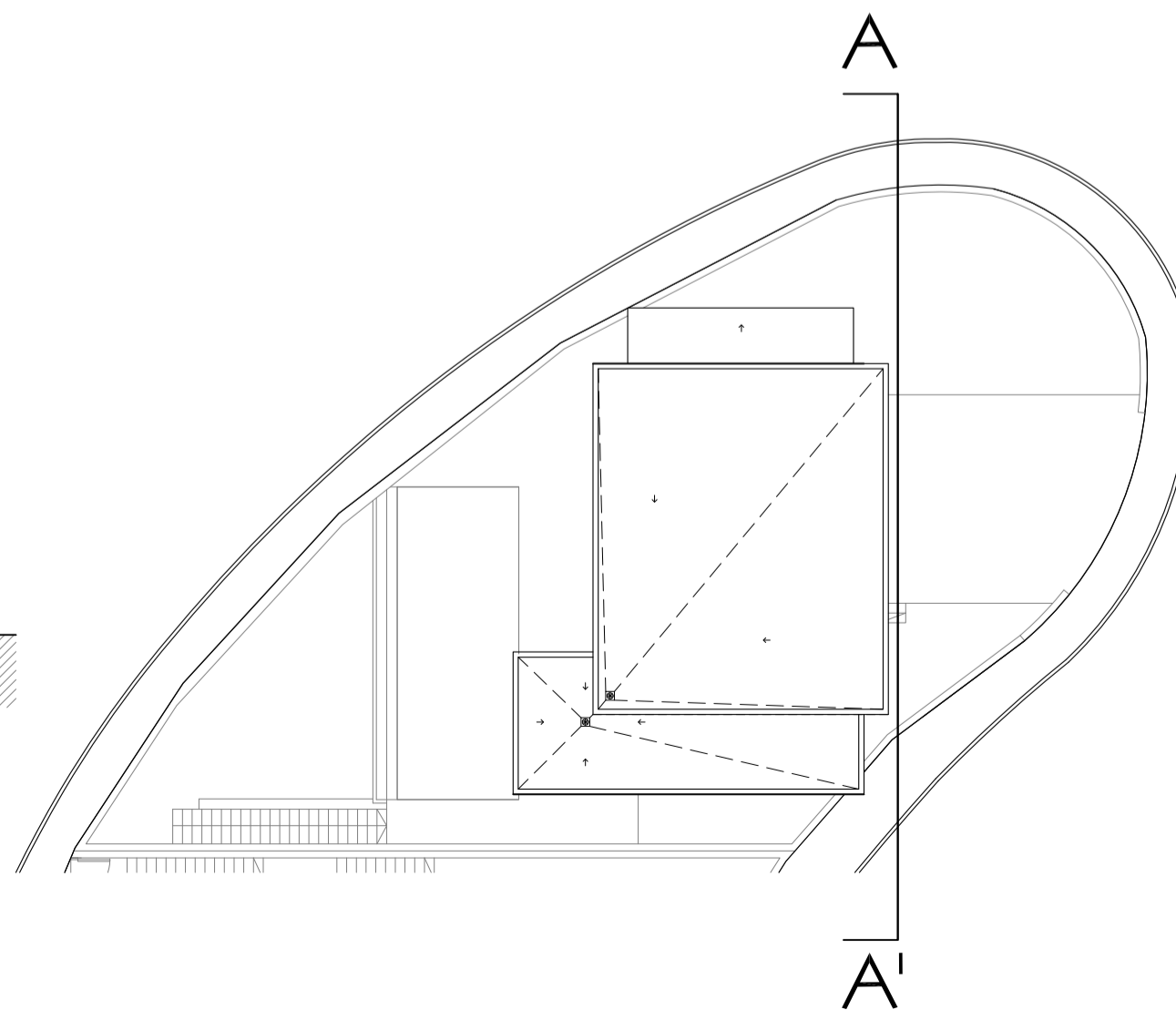

CUMBRE VILLAS

Amazing Villas, Stunning Views

+34 958 611 809

+34 647 881 853

sales@cumbrevillas.com

www.cumbrevillas.com

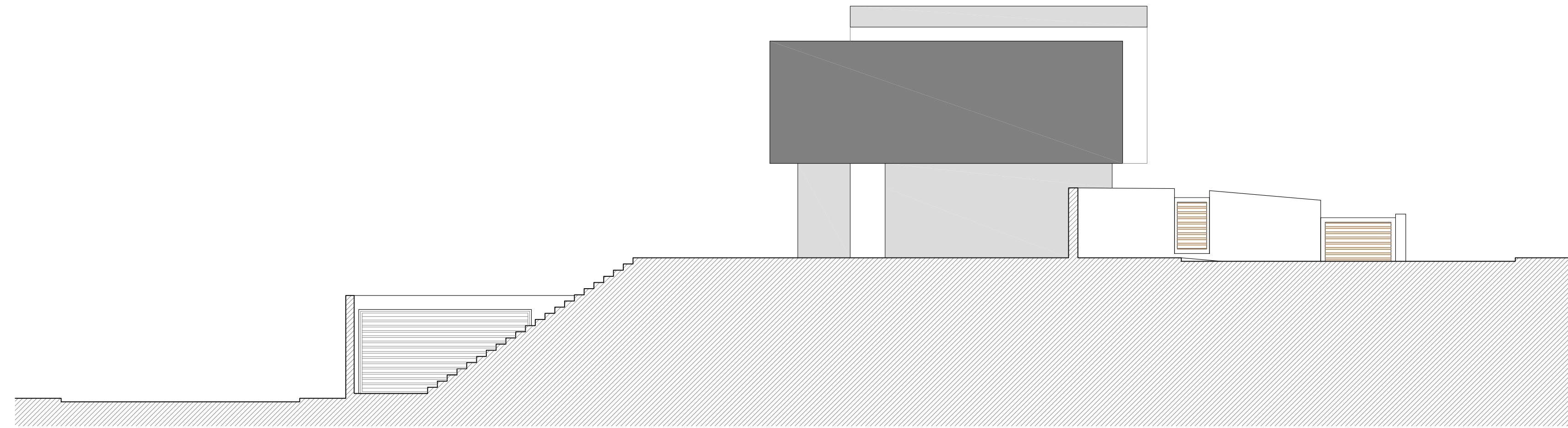

SECCION BB'

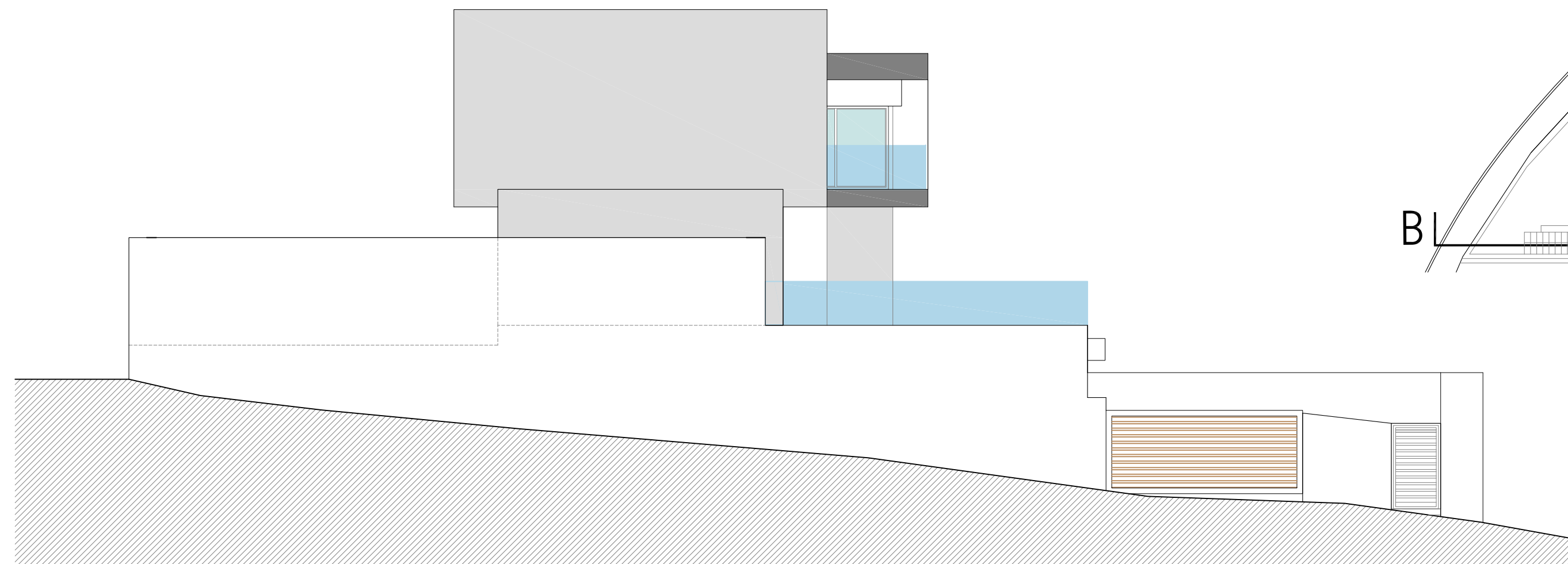
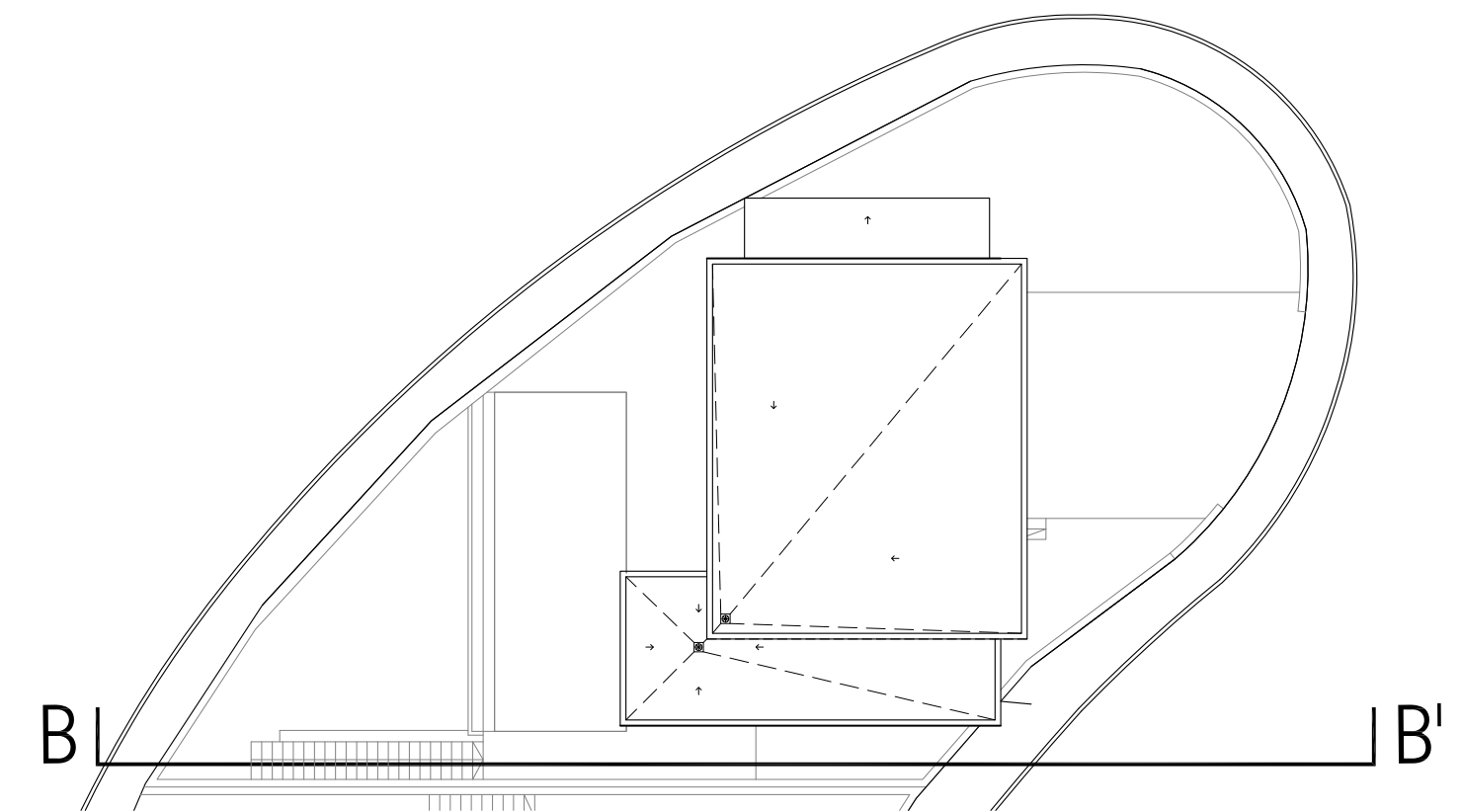
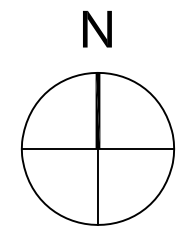

ALZADO NORTE



CUMBRE VILLAS

Amazing Villas, Stunning Views

+34 958 611 809

+34 647 881 853

sales@cumbrevillas.com

www.cumbrevillas.com

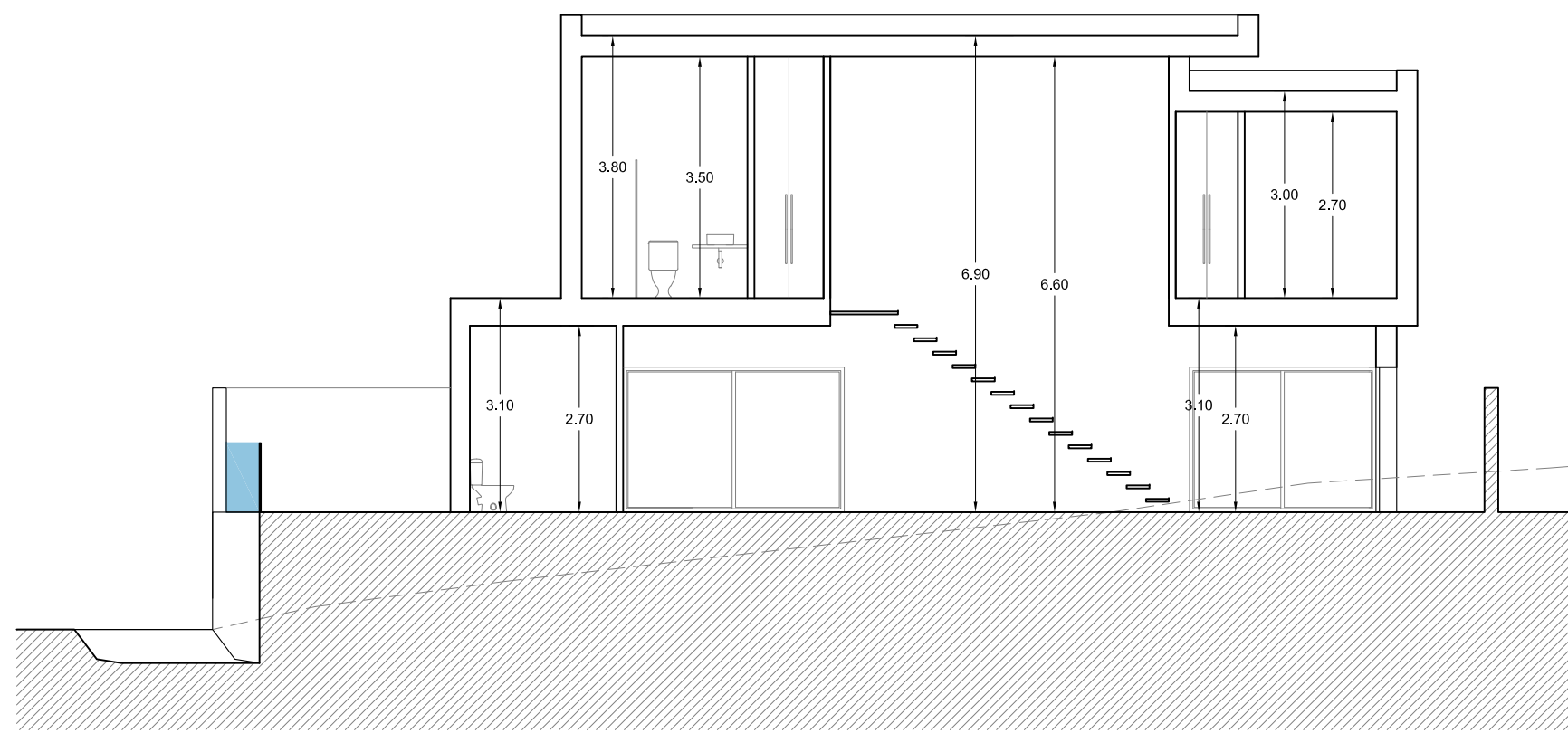

SECCION EE'

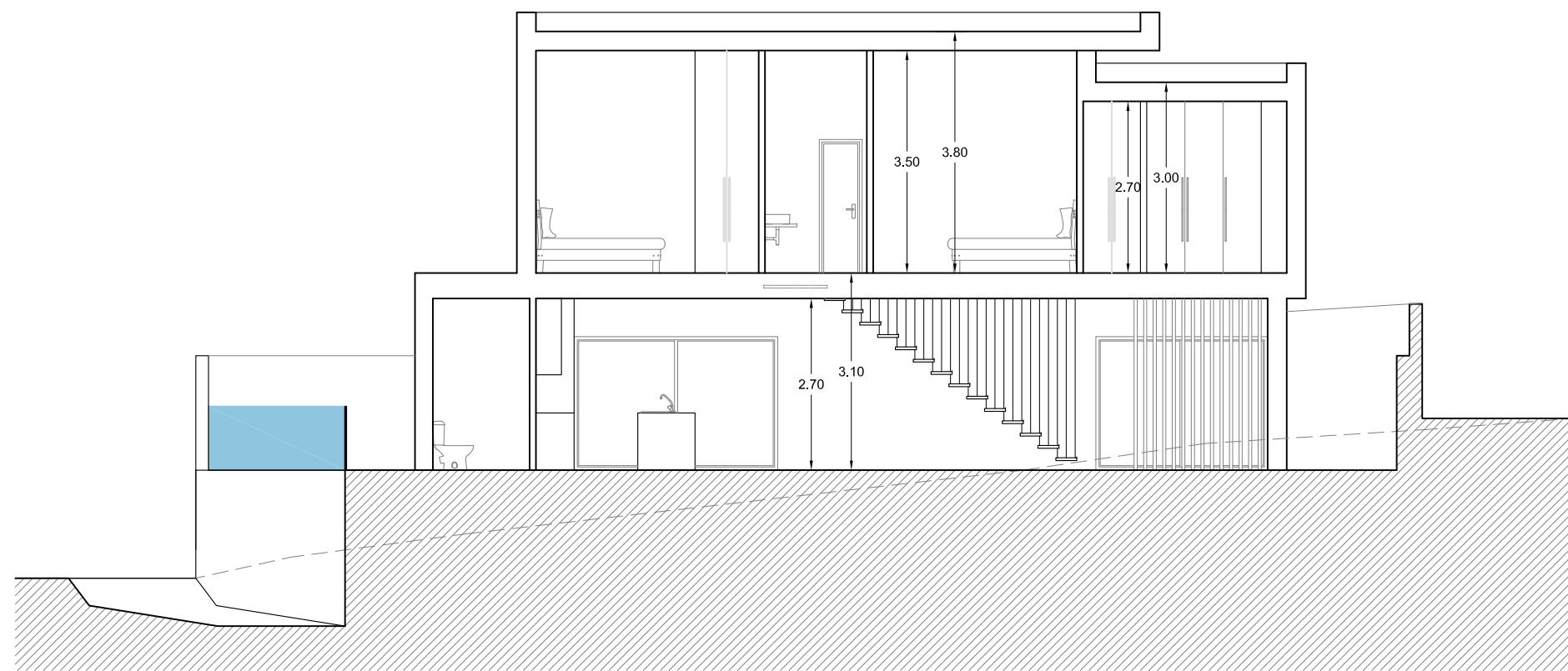

SECCION DD'

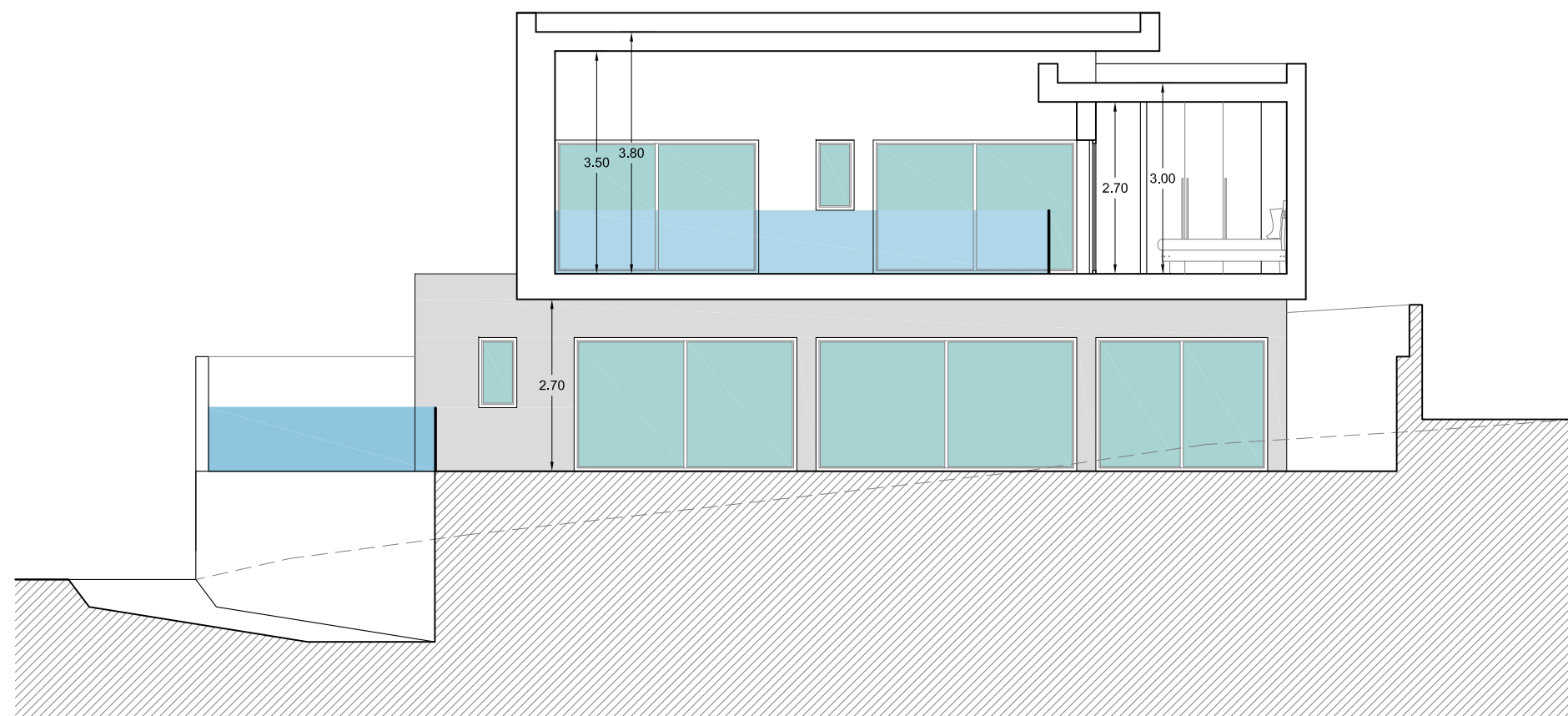

SECCION CC'

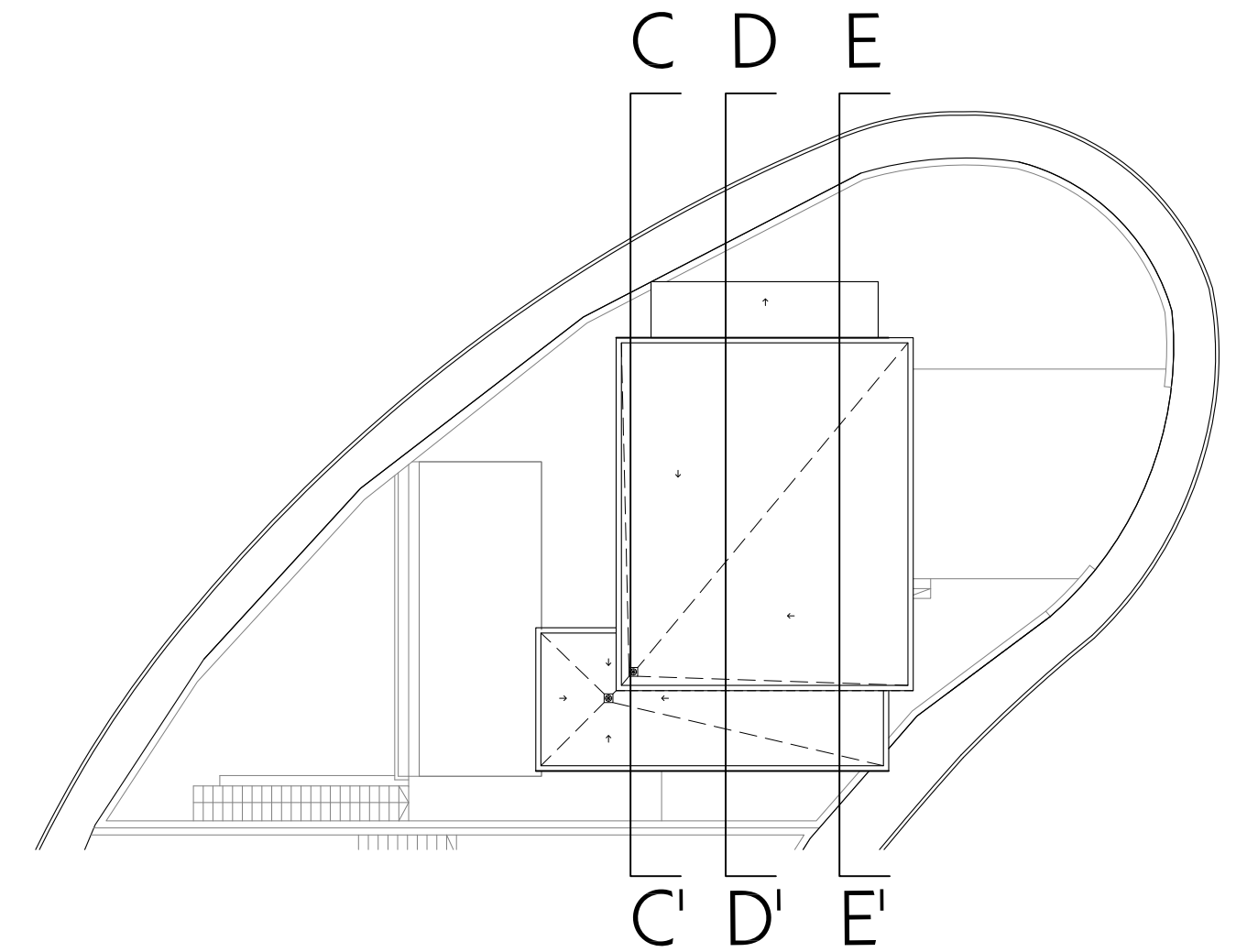

CUMBRE VILLAS

Amazing Villas, Stunning Views

+34 958 611 809

+34 647 881 853

sales@cumbrevillas.com

www.cumbrevillas.com

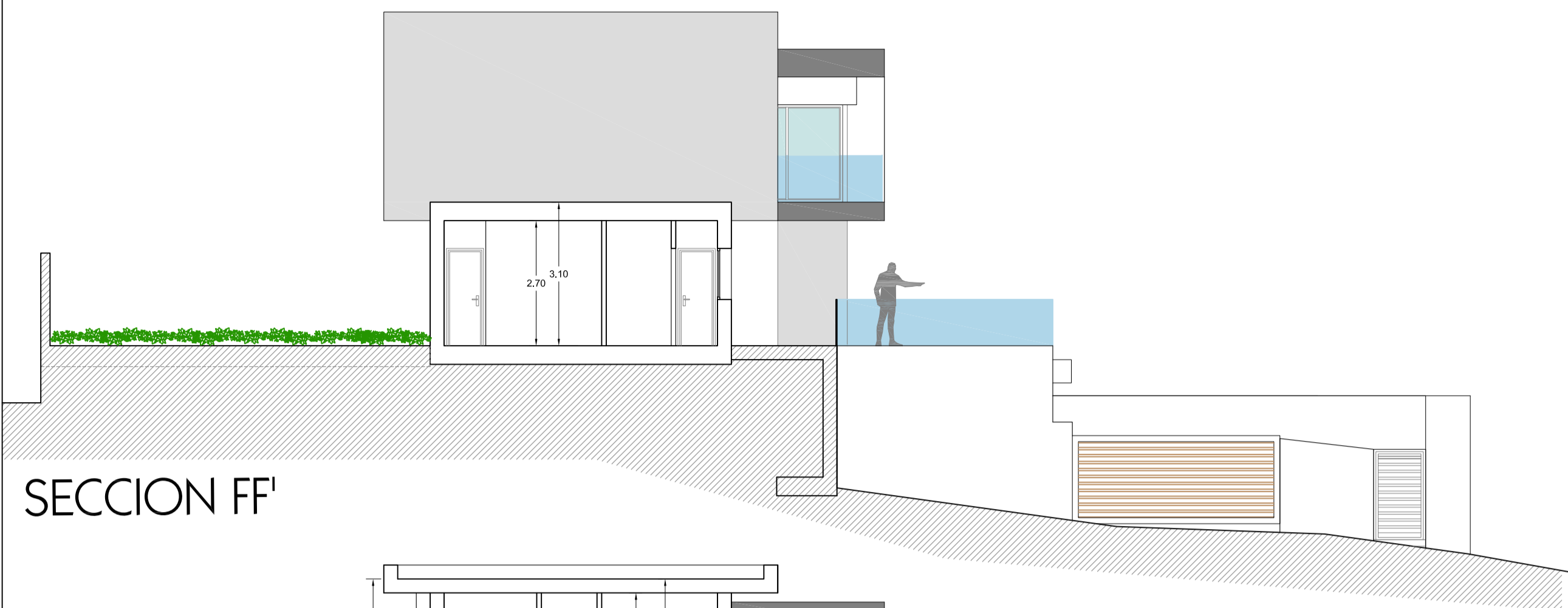

SECCION FF'

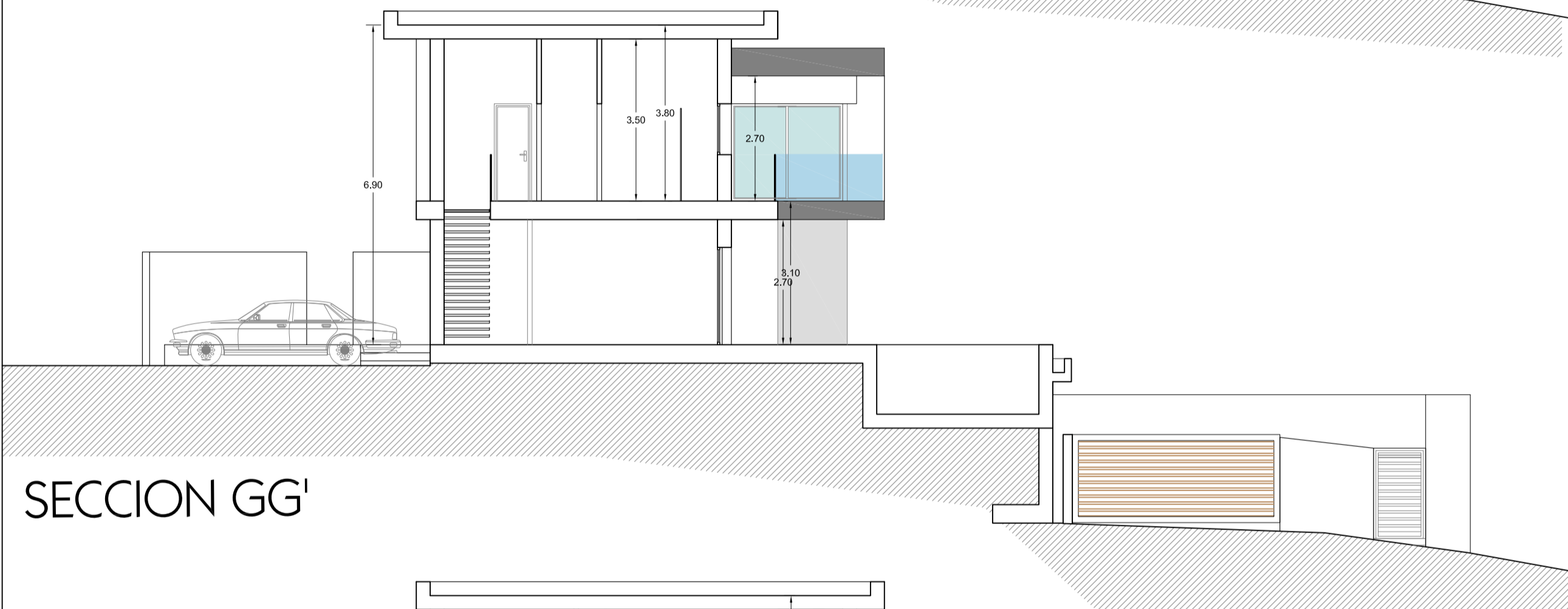

SECCION GG'

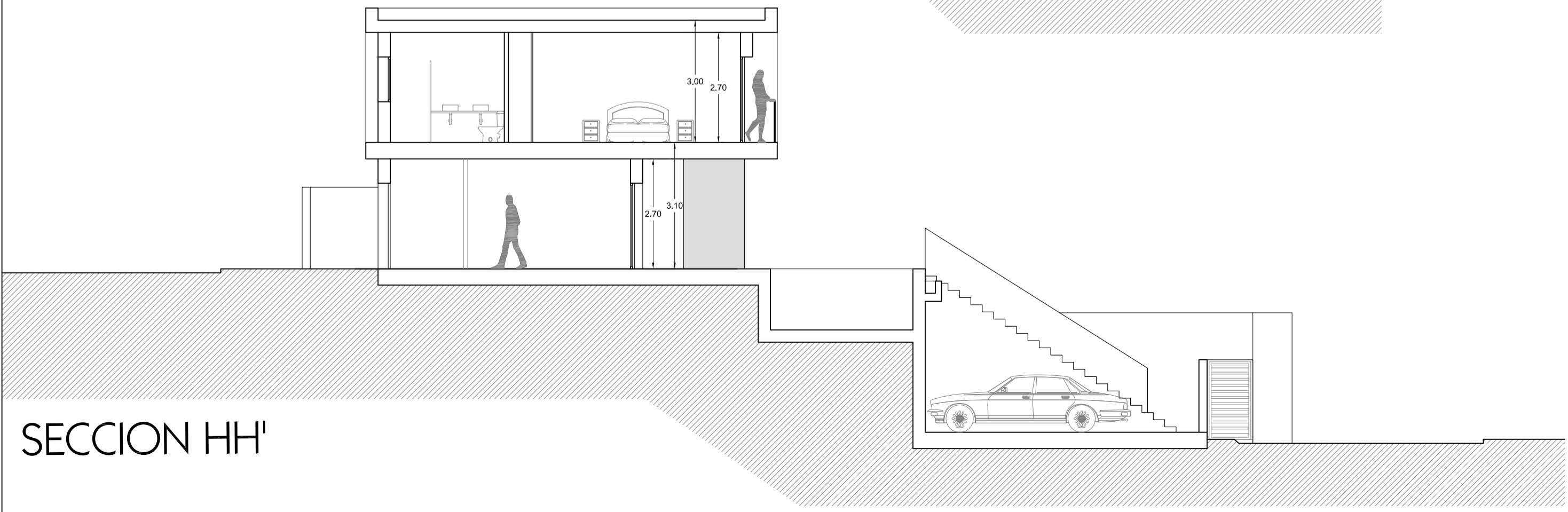

SECCION HH'

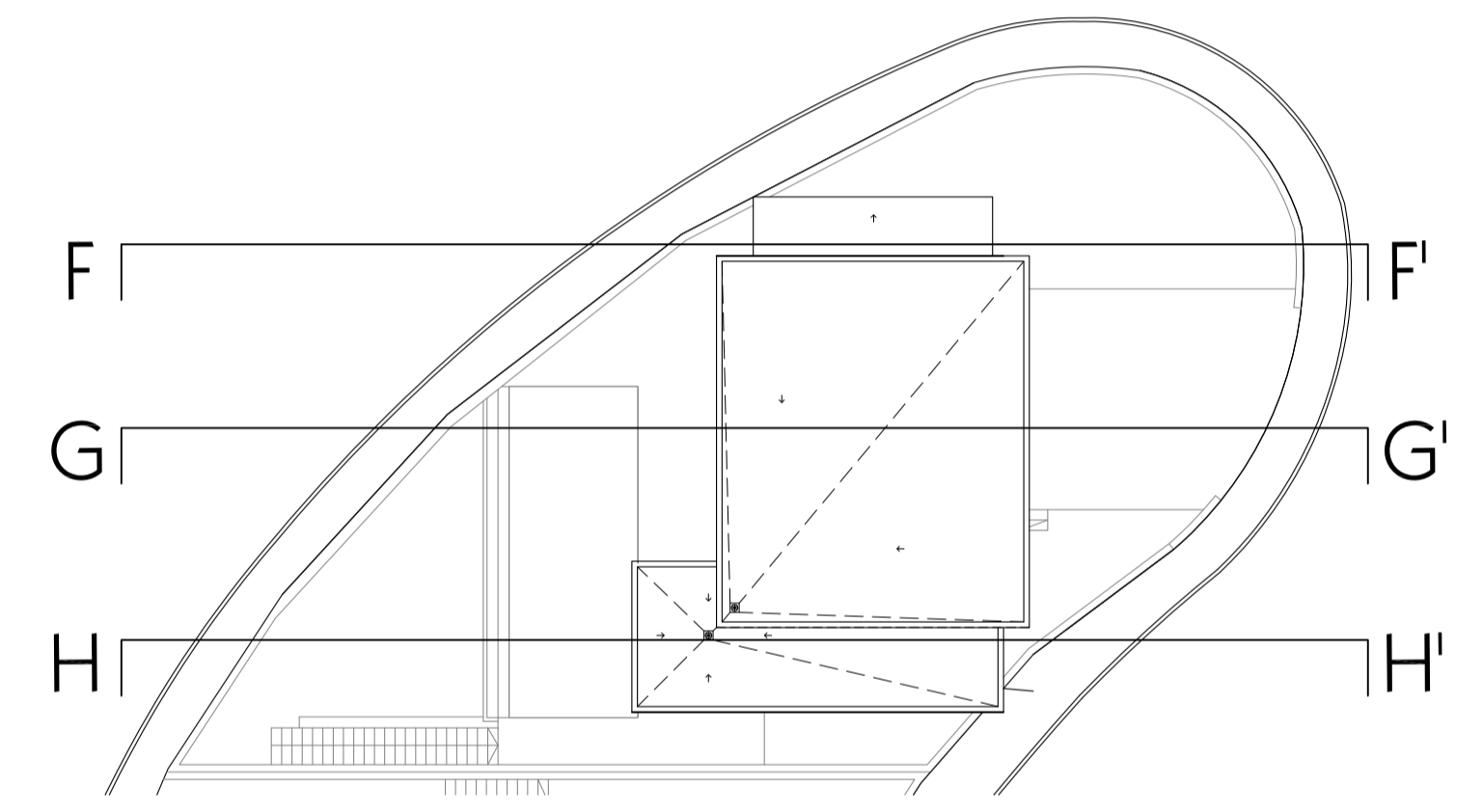

CUMBRE VILLAS
Amazing Villas, Stunning Views

+34 958 611 809

+34 647 881 853

sales@cumbrevillas.com

www.cumbrevillas.com